



[qr.hilti.com/  
manual/?id=2481766](http://qr.hilti.com/manual/?id=2481766)

## Hilti KWIK-X $\varnothing 5/8'' + \varnothing 3/4''$

KHC + KH-EZ

KHC + KH-EZ CRC



(B)



(A, B)



(B)

### KHC WARNING

**Contains:** 2-Propenoic acid, 2-methyl-, monoester with 1,2-propanediol (A), 1,4-Butanediol dimethacrylate (A), 4-tert-butylpyrocatechol (A), dibenzoyl peroxide (B), Heating may cause a fire. (B), May cause an allergic skin reaction. (A, B), Causes serious eye irritation. (B), Very toxic to aquatic life with long lasting effects. (B)



English  
Français  
Español  
Português





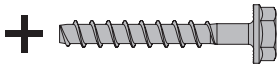











ESR-5065



KH-EZ  
KH-EZ CRC

	ICC ES					
1	✓ ESR-5065					→
1A	-					→

1		9	
2		10	
3		11	
4		12	
5		13	
6		14	
7		15	
8		16	

**EN** 1 Uncracked concrete; 2 Cracked concrete; 3 Dry concrete; 4 Water saturated concrete; 5 Concrete temperature; 6 Capsule temperature; 7 Go to page X in the document; 8 Curing time for 100% loading; 9 Hammer drilling; 10 Hollow drill bit; 11 Diamond coring; 12 Impact tool gear setting; 13 Borehole cleaning required (follow detailed instructions); 14 No borehole cleaning required; 15 Screw anchor; 16 Adhesive Capsule

**FR** 1 Béton non lézardé ; 2 Béton lézardé ; 3 Matériau de base sec ; 4 Matériau de base saturé d'eau ; 5 Température du béton ; 6 Température de la capsule ; 7 Aller à la page X dans le document ; 8 Temps de durcissement pour charge 100 % ; 9 Perçage avec percussion ; 10 Foret creux ; 11 Forage au diamant ; 12 Réglage de l'engrenage de l'outil à impact ; 13 Nettoyage nécessaire du trou foré (suivre les instructions détaillées) ; 14 Aucun nettoyage nécessaire du trou foré ; 15 Vis d'ancrage ; 16 Capsule adhésive

**ES** 1 Hormigón no fisurado; 2 Hormigón fisurado; 3 Superficie de trabajo seca; 4 Superficie de trabajo saturada de agua; 5 Temperatura del hormigón; 6 Temperatura de la cápsula; 7 Diríjase a la página X del document; 8 Tiempo de fraguado para una carga del 100 %; 9 Taladro con percusión; 10 Taladro con broca hueca y aspiración; 11 Taladro con diamante; 12 Ajuste del mecanismo de la herramienta de impacto; 13 Limpieza del taladro requerida (siga las instrucciones detalladas); 14 No es necesaria la limpieza del taladro; 15 Anclaje tornillo; 16 Cápsula del mortero

**PT** 1 Betão não fissurado; 2 Betão fissurado; 3 Material base seco; 4 Material base saturado de água; 5 Temperatura do betão; 6 Temperatura da cápsula; 7 Vá até à página X no documento; 8 Tempo de cura para 100 % de carga; 9 Perfurar de martelo; 10 Broca de coroa oca; 11 Perfurar com equipamento diamantado; 12 Ajuste da velocidade da ferramenta de impacto; 13 Borehole cleaning required (follow detailed instructions); 14 Não é necessário limpar o furo; 15 Parafuso para betão; 16 Cápsula de resina



+5°C ... 40°C /  
41°F ... 104°F



-28°C ... 40°C /  
-18.4°F ... 104°F



$t_{\text{cure, full}}$

[°C]

[°F]

[°C]

[°F]

-28 ... -10

-18 ... 14

5 ... 40

41 ... 104

24 h

-10 ... 5

14 ... 41

5 ... 40

41 ... 104

30 min

5 ... 40

41 ... 104





5 ... 40

41 ... 104

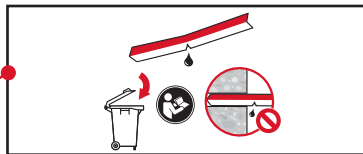
0.5 min

KHC X/X" XXXX



				
KH-EZ	5/8"	3 1/4" – 4 1/2"	KHC 5/8" SMALL	→ 
		> 4 1/2" – 7 1/2"	KHC 5/8" LARGE	
KH-EZ CRC	3/4"	4" – 4 1/2"	KHC 3/4" SMALL	→ 
		> 4 1/2" – 8 1/4"	KHC 3/4" LARGE	

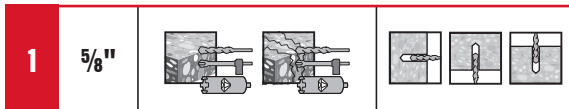

ICC  
ES  
ESR-5065

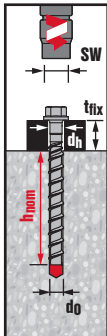

KH-EZ KH-EZ CRC	$h_{nom}$	KHC	$d_o$	$d_h$	SW			
						SIW4-22 NURON	SIW6-22 NURON	SIW8-22 NURON
$\frac{5}{8}$ "	$3 \frac{1}{4}$ " – $4 \frac{1}{2}$ "	$\frac{5}{8}$ " SMALL	$\frac{5}{8}$ "	$\frac{3}{4}$ "	$\frac{15}{16}$ "			
	$> 4 \frac{1}{2}$ " – $7 \frac{1}{2}$ "	$\frac{5}{8}$ " LARGE						

1

5/8"

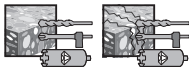

ICC  
ES  
ESR-5065

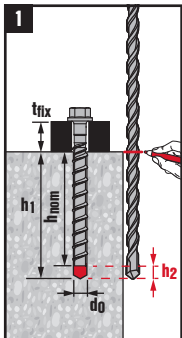

		d0	5/8"		
		h1	h <sub>nom</sub> + h <sub>2</sub>		
		h <sub>nom</sub>	3 1/4" - 4 1/2" > 4 1/2" - 7 1/2"		
		h <sub>2</sub>	3/8"	→	10 2a
			1"	→	10 2b
			3/8"	→	10 2b
		h <sub>2</sub>	3/8"	→	10 2b
			3/8"	→	11 2d

1

3/4"

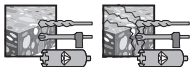

ICC  
ES  
ESR-5065

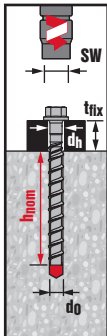

KH-EZ KH-EZ CRC	$h_{nom}$	KHC	$d_o$	$d_h$	SW			
						SIW4-22 NURON	SIW6-22 NURON	SIW8-22 NURON
3/4"	4" - 4 1/2"	3/4" SMALL	3/4"	7/8"	1 1/8"			
	> 4 1/2" - 8 1/4"	3/4" LARGE						

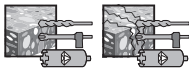

1

 $\frac{3}{4}''$ 
**ICC**  
**ES**

ESR-5065

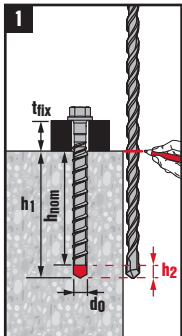

		$d_0$	$\frac{3}{4}''$		
		$h_1$	$h_{nom} + h_2$		
		$h_{nom}$	$4'' - 4 \frac{1}{2}''$	$> 4 \frac{1}{2}'' - 8 \frac{1}{4}''$	
		$h_2$	$\frac{3}{8}''$	→	10 2a
			1"	→	10 2b
			$\frac{3}{8}''$	→	10 2b
			$\frac{3}{8}''$	→	10 2c
			$\frac{3}{8}''$	→	11 2d

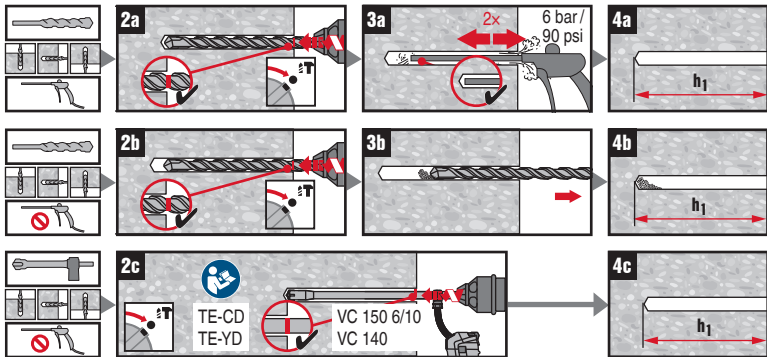

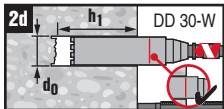

SPX-T		d <sub>0</sub> [inch]	5/8"	3/4"
HIT-RB		[inch]	5/8"	3/4"

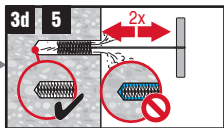
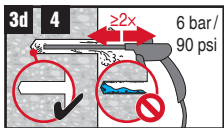
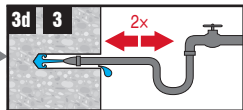
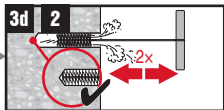
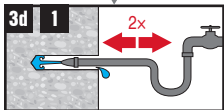

ICC  
**ES**  
ESR-5065

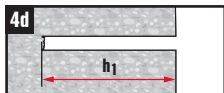

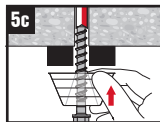
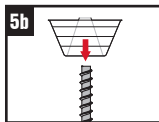
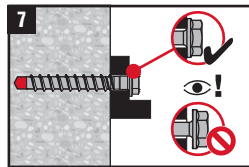
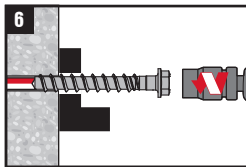
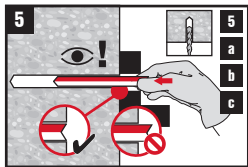

ICC  
**ES**

ESR-5065



1A

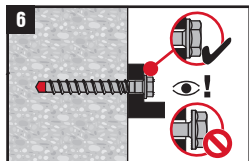
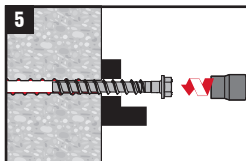
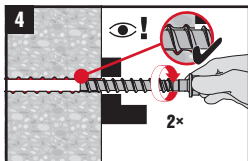
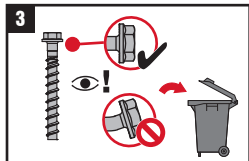
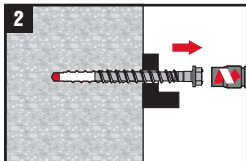
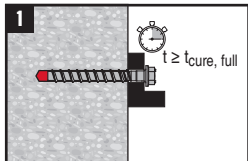
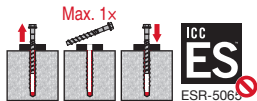
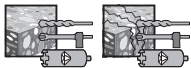

EN

Hilti KHC



**Contains:** 2-Propenoic acid, 2-methyl-, monoester with 1,2-propanediol (A), 1,4-Butanediol dimethacrylate (A), 4-tert-butylpyrocatechol (A), dibenzoyl peroxide (B)

**WARNING** Heating may cause a fire. | May cause an allergic skin reaction. | Causes serious eye irritation. | Very toxic to aquatic life with long lasting effects. | Keep away from heat/sparks/open flames/hot surfaces. | No smoking. Wear eye protection, protective clothing, protective gloves. | Do not get in eyes, on skin, or on clothing. | **IF IN EYES:** Rinse cautiously with water for several minutes. Remove contact lenses, if present and easy to do. Continue rinsing. | **IF ON SKIN:** Wash with plenty of soap and water. If eye irritation persists: Get medical advice/attention. If skin irritation or rash occurs: Get medical advice/attention.

**Disposal considerations:** Unusable foil capsules e.g. if expiry date has been exceeded, should be disposed of as hazardous waste material under observance of the official regulations. EAK code no.: 08 04 09\* / 20 01 27\*

**Product Information:** Always keep this Instruction for Use together with the product. | Ensure that the Instruction for Use is with the product when it is given to other persons. | **Installation temperature (base material, screw anchor):**  $-28^{\circ}\text{C}$  to  $40^{\circ}\text{C}$  /  $-18^{\circ}\text{F}$  to  $104^{\circ}\text{F}$ . | **Transport and storage instructions:** Store in a cool, dry and dark place only in the original packaging. | Transport temperature:  $5^{\circ}\text{C}$  to  $25^{\circ}\text{C}$  /  $41^{\circ}\text{F}$  to  $77^{\circ}\text{F}$ . | Storage temperature:  $5^{\circ}\text{C}$  to  $25^{\circ}\text{C}$  /  $41^{\circ}\text{F}$  to  $77^{\circ}\text{F}$ . | **Suitable for anchor fastenings in concrete with a minimum compressive strength of 17.2 N/mm<sup>2</sup> (2500 psi) to 58.6 N/mm<sup>2</sup> (8500 psi).** | **ICC-ES ESR-5065 must be observed!** For any application not covered by this document, contact Hilti.

### **▲ WARNING**

**▲ Poor load values / potential failure of fastening.** Do not use capsules after expiry date, after exceeding the storage and transport temperatures or if mechanically damaged (leaking)! | Ensure the correct length of the borehole by marking of the embedment depth on the drill bit and checking, that the hole is drilled to the correct depth before setting of screw. | Hilti hollow drill bits TE-CD, TE-YD must be used in conjunction with a properly maintained Hilti vacuum cleaner with model and suction capacity (volumetric flow rate) as specified. | Borehole must be free of water, ice, oil, bitumen, chemicals or any other foreign matter or contaminants. | Ensure that the specified screw anchor size and capsule size are fitting together.

**For diamond coring:** Ensure correct borehole diameter and use of Hilti DD-30 with SPX-T core bits.

**For overhead application:** Use HIT-OHC as a drip guard.

FR

Hilti KHC



**Contient :** Acide 2-propénoate, 2-méthyl-, monoester avec 1,2-propanediol (A), Diméthacrylate de 1,4-butanediol (A), 4-tert-butylpyrocatechol (A), peroxyde de dibenzoyle (B)

**ATTENTION** Peut s'enflammer sous l'effet de la chaleur. | Peut provoquer une allergie cutanée. | Provoque une sévère irritation des yeux. | Très toxique pour les organismes aquatiques, entraîne des effets néfastes à long terme. | Tenir à l'écart de la chaleur/des étincelles/des flammes nues/des surfaces chaudes. | Ne pas fumer. Porter un équipement de protection des yeux, des vêtements de protection, des gants de protection. | Éviter tout contact avec les yeux, la peau ou les vêtements. | **EN CAS DE CONTACT AVEC LES YEUX :** Rincer avec précaution à l'eau pendant plusieurs minutes. Enlever les lentilles de contact si la victime en porte et si elles peuvent être facilement enlevées. Continuer à rincer. | **EN CAS DE CONTACT AVEC LA PEAU :** laver abondamment à l'eau et au savon. Si l'irritation oculaire persiste: consulter un médecin. En cas d'irritation ou d'éruption cutanée: consulter un médecin.

**Indications de recyclage :** Les capsules non utilisables (par ex. si la date de péremption est dépassée) doivent être éliminées dans les prescriptions réglementaires en vigueur en matière de déchets spéciaux. Réf. EAK : 08 04 09\* / 20 01 27\*

**Information produit :** Le présent mode d'emploi doit toujours être conservé avec le produit. | Ne pas donner le produit à un autre utilisateur sans lui fournir le mode d'emploi. | **Température de travail (matériau support, vis d'ancrage) :** -28 °C à 40 °C / -18 °F à 104 °F. | **Instructions de transport et de stockage :** Conserver dans un endroit frais, sec et à l'abri de la lumière et uniquement dans l'emballage d'origine. | Température de transport : 5 °C à 25 °C / 41 °F à 77 °F. | Température de stockage : 5 °C à 25 °C / 41 °F à 77 °F. | **Convient pour les fixations par ancrage dans le béton avec une résistance à la compression minimale de 17.2 N/mm<sup>2</sup> (2500 psi) à 58.6 N/mm<sup>2</sup> (8500 psi).** | **ICC-ES ESR-5065 doit être observé !** En cas d'applications qui ne sont pas décrites dans le présent mode d'emploi, s'adresser à Hilti.

### ⚠ ATTENTION

**⚠ Mauvaise fixation / défaillance de la fixation.** Ne pas utiliser de gélules après la date de péremption, après avoir dépassé les températures de stockage et de transport ou si elles sont mécaniquement endommagées (fuites) ! | Assurez-vous de la longueur correcte du trou de forage en marquant la profondeur d'enfoncement sur le foret et en vérifiant que le trou est percé à la bonne profondeur avant le réglage de la vis. | Les mèches creuses Hilti TE-CD, TE-YD doivent être associées à un modèle d'aspirateur Hilti bien entretenu d'une capacité d'aspiration (débit volumétrique) conforme à la spécification. | Les trous de perçage doivent être exempts de humidité, glace, huile, bitume, produits chimiques ou autres corps étrangers. | Assurez-vous que la taille de la vis d'ancrage et la taille de la capsule spécifiées s'emboîtent.

**En cas de forage diamant :** Assurez-vous que le diamètre de forage est correct et que vous utilisez le Hilti DD-30 avec les trépan SPX-T.

**En cas d'application au plafond :** utiliser HIT-OHC comme anti-gouttes.

ES

Hilti KHC



**Contiene:** Ácido 2-propanoico, 2-metilo, monoéster con 1,2-propanodiol (A), Dimetacrilato de 1,4-butanodiol (A), 4-tert-butilpirocatecol (A), peróxido de dibenzoilo (B)

**ATENCIÓN Peligro de incendio en caso de calentamiento.** | Puede provocar una reacción alérgica en la piel. | Provoca irritación ocular grave. | Muy tóxico para los organismos acuáticos, con efectos nocivos duraderos. | Mantener alejado de fuentes de calor, chispas, llama abierta o superficies calientes. | No fumar. Llevar gafas de protección, prendas de protección, guantes de protección. | Evitar el contacto con los ojos, la piel o la ropa. | **EN CASO DE CONTACTO CON LOS OJOS:** Aclarar cuidadosamente con agua durante varios minutos. Quitar las lentes de contacto, si lleva y resulta fácil. Seguir aclarando. | **EN CASO DE CONTACTO CON LA PIEL:** Lavar con agua y jabón abundantes. Si persiste la irritación ocular: Consultar a un médico. En caso de irritación o erupción cutánea: Consultar a un médico.

**Indicaciones para la eliminación:** las cápsulas de láminas que no pueden utilizarse (p. ej., si se ha sobrepasado la fecha de caducidad) deben eliminarse como residuos especiales conforme a la normativa aplicable. Código CER: 08 04 09\* / 20 01 27\*

**Información del producto:** Guarde siempre estas instrucciones de uso junto con el producto. | En caso de entregar el producto a terceros, deben incluirse siempre las instrucciones de uso. | **Temperatura de procesamiento (superficie de trabajo, ancla de tornillo):**  $-28\text{ }^{\circ}\text{C} \dots 40\text{ }^{\circ}\text{C} / -18\text{ }^{\circ}\text{F} \dots 104\text{ }^{\circ}\text{F}$ . | **Instrucciones de transporte y almacenamiento:** Consérvese siempre en su embalaje original en un lugar fresco, seco y oscuro. | Temperatura de transporte:  $5\text{ }^{\circ}\text{C} \dots 25\text{ }^{\circ}\text{C} / 41\text{ }^{\circ}\text{F} \dots 77\text{ }^{\circ}\text{F}$ . | Temperatura de almacenamiento:  $5\text{ }^{\circ}\text{C} \dots 25\text{ }^{\circ}\text{C} / 41\text{ }^{\circ}\text{F} \dots 77\text{ }^{\circ}\text{F}$ . | **Apropiado para anclajes en hormigón con una resistencia a la presión mínima de  $17.2\text{ N/mm}^2 \dots 58.6\text{ N/mm}^2$  (2500 psi...8500 psi).** | **ICC-ES ESR-5065 debe ser observado!** Para aplicaciones no descritas en las presentes instrucciones de uso, póngase en contacto con Hilti.

### ⚠ ATENCIÓN

**⚠ Valores de sujeción deficientes o fallo de la fijación.** ¡No use las cápsulas después de la fecha de caducidad, después de exceder las temperaturas de almacenamiento y transporte o si están dañadas mecánicamente (fugas)! Compruebe que la profundidad de los agujeros es la correcta antes de la fijar el anclaje. | Las brocas huecas TE-CD, TE-YD de Hilti deben utilizarse con una aspiradora de Hilti en buen estado de funcionamiento del modelo y la capacidad de succión (tasa de flujo volumétrico) que se especifican. | Los agujeros deben estar libres de humedad, hielo, aceite, betún, sustancias químicas y otros cuerpos extraños o impurezas. | Asegúrese de que el tamaño de anclaje de tornillo especificado y el tamaño de la cápsula encajen.

**En caso de taladro de núcleo de diamante:** Asegúrese de que el diámetro del pozo sea correcto mediante el uso de Hilti DD-30 con brocas de perforación SPX-T para extracción de testigos con diamante.

**En aplicaciones por encima de la cabeza:** Utilizar el accesorio HIT-OHC como protección antigoteo.



PT

Hilti KHC



**Contém:** Ácido 2-propenóico, 2-metil-, monoéster com 1,2-propanodiol (A), Dimetacrilato de 1,4-butanodiol (A), 4-terc-butilpirocatecol (A), peróxido de dibenzóilo (B)

**ATENÇÃO** Risco de incêndio sob a acção do calor. | Pode provocar uma reacção alérgica cutânea. | Provoca irritação ocular grave. | Muito tóxico para os organismos aquáticos com efeitos duradouros. | Manter afastado do calor/faixa/chama aberta/superfícies quentes. | Não fumar. Usar proteção ocular, vestuário de proteção, luvas de proteção. | Não pode entrar em contacto com os olhos, a pele ou a roupa. | **SE ENTRAR EM CONTACTO COM OS OLHOS:** enxaguar cuidadosamente com água durante vários minutos. Se usar lentes de contacto, retire-as, se tal lhe for possível. Continuar a enxaguar. | **SE ENTRAR EM CONTACTO COM A PELE:** lavar com sabonete e água abundantes. Caso a irritação ocular persista: Consulte um médico. Em caso de irritação ou erupção cutânea: Consulte um médico.

**Recomendação sobre a eliminação:** Cápsulas inutilizáveis (p. ex., devido a prazo de validade excedido) devem ser eliminadas como resíduos especiais, de acordo com as normas e regulamentações legais. Código LER: 08 04 09\* / 20 01 27\*

**Dados informativos sobre o produto:** Guarde estas instruções de utilização sempre em conjunto com o produto. | Entregue o produto a outras pessoas apenas juntamente com as instruções de utilização. | **Temperatura de aplicação (material base, âncora de parafuso):** -28 °C até 40 °C / -18 °F até 104 °F. |

**Indicações de transporte e de armazenamento:** Guarde em lugar fresco, seco, ao abrigo da luz e apenas na embalagem original. | Temperatura de transporte: 5 °C até 25 °C / 41 °F até 77 °F. | Temperatura de armazenamento: 5 °C até 25 °C / 41 °F até 77 °F. | **Para fixações por ancoragem em betão com uma força mín. de compressão de 17.2 N/mm<sup>2</sup> (2500 psi) até 58.6 N/mm<sup>2</sup> (8500 psi).** | **ICC-ES ESR-5065 deve ser observado!** Em caso de aplicações que não se encontrem descritas nas presentes instruções de utilização, é favor dirigir-se à Hilti.

### ⚠ ATENÇÃO

**⚠ Valores de retenção deficientes/falha da fixação.** Não use cápsulas após o prazo de validade, após ultrapassar as temperaturas de armazenamento e transporte ou se houver danos mecânicos (vazamentos)! | Certifique-se do comprimento correto do poço marcando a profundidade de embutimento na broca e verificando se o orifício foi perfurado na profundidade correta antes de ajustar o parafuso. | A brocas de perfuração ocas Hilti TE-CD e TE-YD têm de ser usadas em conjunto com um aspirador Hilti em boas condições de funcionamento e com o modelo e capacidade de aspiração (débito volumétrico) especificados. | Os furos deverão estar sem humidade, gelo, óleo, betume, produtos químicos ou outros objetos estranhos e contaminantes. | Certifique-se de que o tamanho da âncora de rosca e o tamanho da cápsula especificados estão ajustados.

**Em perfurações com perfuradores diamantados:** Garanta o diâmetro correto do poço e use Hilti DD-30 com brocas SPX-T.

**No caso de aplicações em suspensão:** utilizar HIT-OHC como protecção anti-gotejamento.

 Hilti Argentina S.R.L. Profesor Manuel García 4760 B1605 BIB - Munro AR-Buenos Aires Tel +54 11 4721 4400  Hilti do Brasil Comercial Ltda Al. Rio Negro, 500 -Torre A, 9º andar 06454-000 Barueri, SP - Brasil T +55 11 4134 9000  Hilti (Canada) Corp. 2360 Meadowpine Boulevard Mississauga, Ontario L5N 6S2 Tel +1 905 813 9200  Hilti Chile Ltda. Av. Apoquindo 4501, piso 13, Las Condes 7550000 Santiago Tel +562 655 3000  Superba S.A. 200 Mts. Oeste de Matra la Uruca CR-San José Tel +506 2255 1044  Hilti Mexicana, S.A. de C.V. Jaime Balmes 8, Oficina 102, 1er Piso Col. Los Morales Polanco Del. Miguel Hidalgo MEX-Mexico City 11510 Tel +5255 5387-1600  Hilti, Inc. Legacy Tower, Suite 1000 7250 Dallas Parkway TX 75024 Plano - USA T +1 9724035800

## Made in Germany

Hilti = registered trademark of  
Hilti Corporation, Schaan, Liechtenstein  
[www.hilti.group](http://www.hilti.group)

© 2026 Right of technical changes reserved S.E. & O



2481766 V6-2026.02.16