



X-P B4 MX

Concrete nails

Data Sheet

[English](#)

[Deutsch](#)

[Français](#)

[Español](#)

[Italiano](#)

[Polski](#)

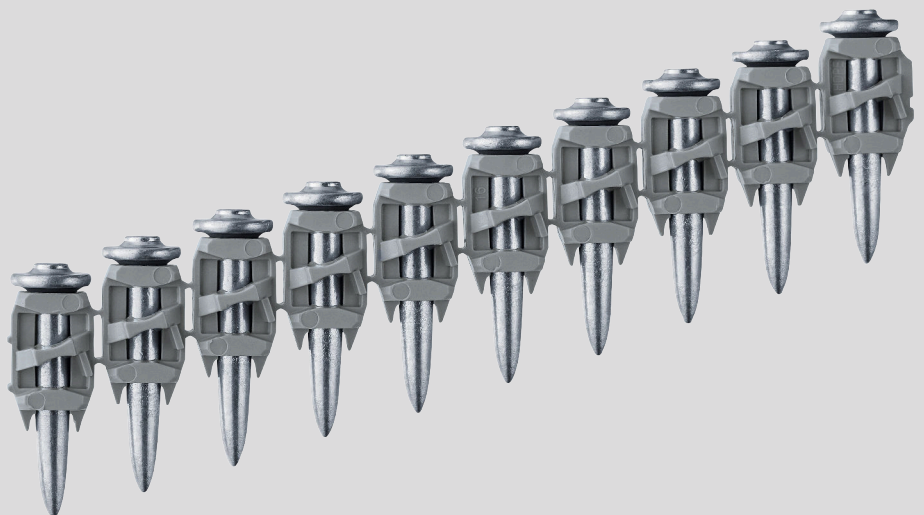



X-P B4 MX

Concrete nails

Data Sheet

[English](#)

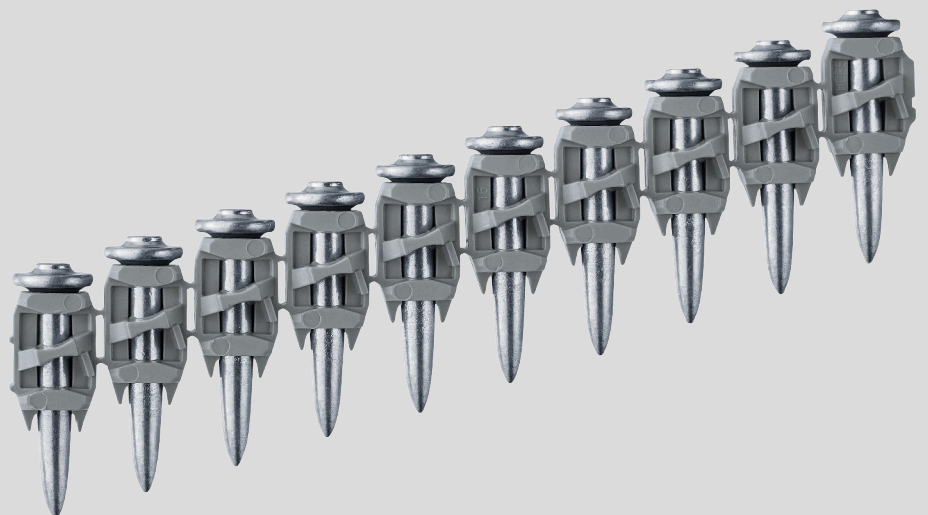

25 Aug 2025

CONTENTS

1	Product information	2
1.1	Product description	2
2	Intended use	2
2.1	Fastening conditions	2
2.2	Base materials	2
2.3	Load conditions	2
2.4	Environmental conditions	3
3	Approvals and certificates	3
4	Product data	3
4.1	Dimensions	3
4.2	Material properties for carbon steel parts	3
4.3	Material properties for plastic parts	4
5	System recommendation	4
5.1	Tool recommendation	4
6	Requirements for intended use	4
6.1	Fastened material properties	4
6.2	Base material properties	5
6.3	Nail length recommendation	5
7	Performance data	6
7.1	Recommended loads under quasi static loading	6
7.2	Stick rate estimation	6
8	Quality assurance	7
8.1	Fastening inspection	7
9	Ordering information	7
9.1	Item number and description	7

1 PRODUCT INFORMATION

1.1 Product description

Designation	Features
X-P B4 MX	 <ul style="list-style-type: none"> • Ultimate-performance nail for soft and some tough concrete • Long, conical tip and high hardness – for excellent fastening quality

2 INTENDED USE

2.1 Fastening conditions

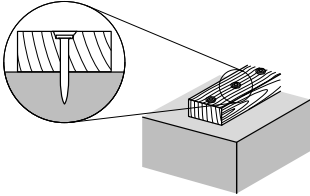
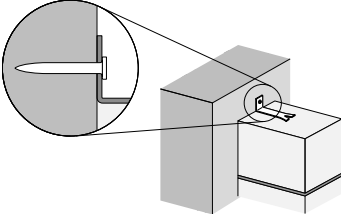
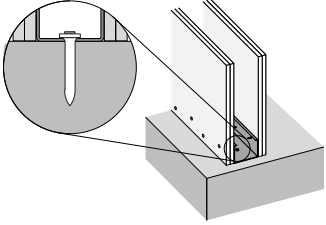
		
Wood to concrete	Steel to concrete	Fixed track fastening

2.2 Base materials

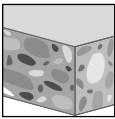
Concrete

2.3 Load conditions

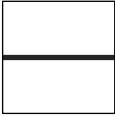
Static / quasi-static

2.4 Environmental conditions

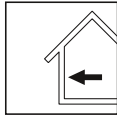

Dry indoor

- For more details, please refer to the [Hilti Corrosion Handbook](#).

3 APPROVALS AND CERTIFICATES

Authority	Approval/Certificate number	Date of issue
Deutsches Institut für Bautechnik (DIBt)	ETA-20/0886	7 Jul 2024

- Please refer to approval/certificate for further information.
- Not all information presented in this product data sheet might be subject to approval/certificate content.
- Information presented in this product data sheet might also be based on Hilti Technical Data.
- Approvals and certificates valid for: X-P 17 B4 MX, X-P 20 B4 MX.

4 PRODUCT DATA

4.1 Dimensions

Technical drawing	Fastener	Head length	Shank length	Shank diameter	Head diameter
		L_h [mm]	L_s [mm]	d_s [mm]	d_h [mm]
	X-P 17 B4 MX	1.8	17	3	6.8
	X-P 20 B4 MX	1.8	20	3	6.8
	X-P 24 B4 MX	1.8	24	3	6.8

4.2 Material properties for carbon steel parts

Fastener	Component part	Material	Coating	Coating thickness	Hardness	Corrosivity category
				t_c [μm]	[HRC]	
X-P B4 MX	Nail	Carbon steel	Zinc coated	≥5	57.5	C1

- Corrosivity category of the atmosphere according to EN ISO 9223.

4.3 Material properties for plastic parts

Fastener	Component part	Material	Color
X-P B4 MX	Magazine strip	High Density Polyethylene (HDPE)	Grey

5 SYSTEM RECOMMENDATION

5.1 Tool recommendation

Fastening condition	Fastener	Tool type
Wood to concrete, Steel to concrete, Fixed track fastening	X-P B4 MX	BX 4-22 (01)

i • For more details, please refer to the chapter Accessories and consumables compatibility in the [Direct Fastening Technology Manual \(DFTM\)](#).

6 REQUIREMENTS FOR INTENDED USE

6.1 Fastened material properties

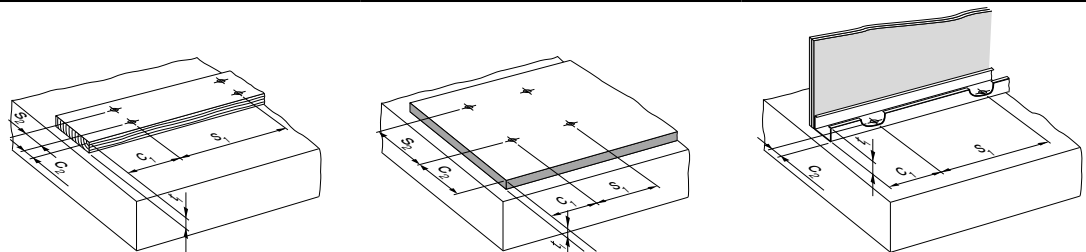

Wood to concrete

Steel to concrete

Fixed track fastening

Fastening condition	Fastener	Fastened material	Fastened material thickness	Edge distance	Edge distance	Fastener spacing distance	Fastener spacing distance
			t ₁ [mm]	c ₁ [mm]	c ₂ [mm]	s ₁ [mm]	s ₂ [mm]
Wood to concrete	X-P B4 MX	Wood	≤25	≥100	≥22	180–800	≥80
Steel to concrete	X-P B4 MX	Steel	≤2	≥40		≥600	≥80
Fixed track fastening	X-P B4 MX	Steel track	≤1	≥40		≤600	≥80

i • Spacing for partition walls with fire rating: 300 mm.

6.2 Base material properties

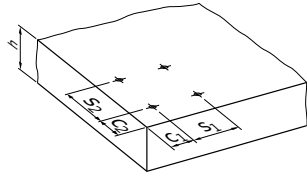

Fastening to concrete

Base material	Base material thickness h [mm]	Edge distance c ₁ [mm]	Edge distance c ₂ [mm]	Fastener spacing distance s ₁ [mm]	Fastener spacing distance s ₂ [mm]
Concrete	≥60	≥70	≥70	≥100	≥80

6.3 Nail length recommendation

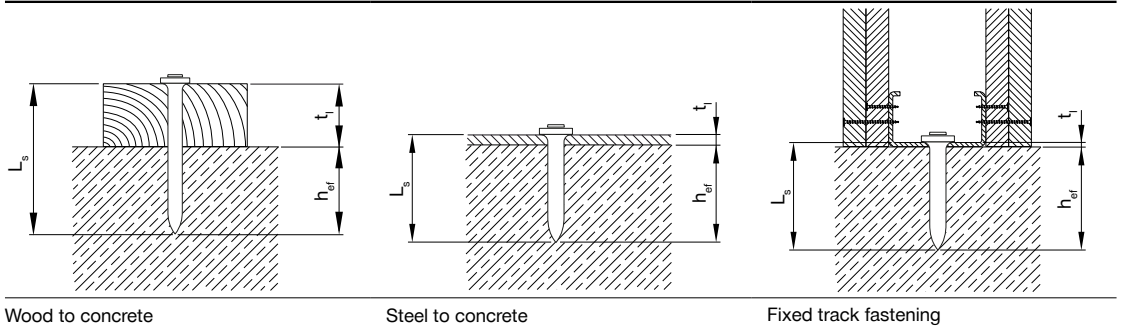

Fastening condition	Fastening characteristics	Shank Length	Embedment depth	Fastened material thickness
		L _s [mm]	h _{ef} [mm]	t ₁ [mm]
Wood to concrete	Standard fastening	$L_s \geq h_{ef} + t_1$	≥14	≤25
	Flush fastening	$L_s \geq h_{ef} + t_1 - 3$	≥14	≤25
Steel to concrete	Standard fastening	$L_s \geq h_{ef} + t_1$	≥11	≤2
Fixed track fastening	Standard fastening	$L_s \geq h_{ef} + t_1$	≥11	≤1

7 PERFORMANCE DATA

7.1 Recommended loads under quasi static loading

Fastening condition	Fastener	Base material type	Embedment depth	Tension load	Shear load
			h_{ef} [mm]	N_{rec} [kN]	V_{rec} [kN]
Wood to concrete	X-P B4 MX	Soft concrete, Medium concrete, Tough concrete	14 - < 18	0.1	0.1
		Soft concrete, Medium concrete	≥ 18	0.2	0.2
Soft concrete, Medium concrete, Tough concrete		11 - < 14	0.1	0.38	
Soft concrete, Medium concrete, Tough concrete		14 - < 18	0.1	0.38	
Steel to concrete, Fixed track fastening		Soft concrete, Medium concrete	≥ 18	0.2	0.38

- Redundancy of fastening points is required.
- Minimum number of fastening points for safety relevant fastenings: ≥ 5 .

7.2 Stick rate estimation

Technical drawing	Fastening condition	Base material type	Stick rate estimation [%]
	Wood to concrete, Steel to concrete, Fixed track fastening	Soft concrete	85 - 98
		Medium concrete	85 - 98
		Tough concrete	70 - 85

- Stick rate can vary from the above values depending on job site conditions.
- The stick rate indicates the percentage of nails that were driven correctly to carry a load.

8 QUALITY ASSURANCE

8.1 Fastening inspection

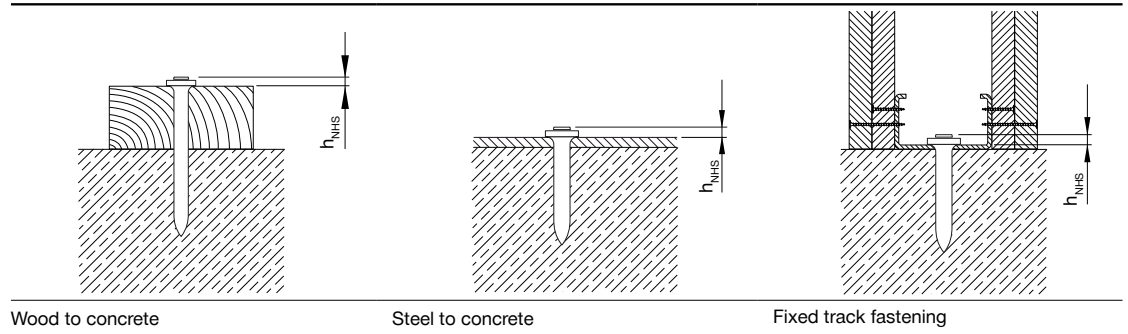

Fastening condition	Fastener	Fastener standoff h_{NHS} [mm]
Wood to concrete	X-P B4 MX	≤ 3
Steel to concrete, Fixed track fastening	X-P B4 MX	2 – 5



- Visible setting failures must be replaced with a new fastener, not in the same hole.
- These are abbreviated instructions which may vary by application.
- Always review/ follow the instructions accompanying the product.

9 ORDERING INFORMATION

9.1 Item number and description

Designation	Item number	Description
X-P 17 B4 MX	2361537, 2361651, 2361655, 2412761, 2412762, 2412763	X-P B4 MX Concrete nails (collated)
X-P 20 B4 MX	2361538, 2361652, 2361656, 2412764, 2412765, 2412766	
X-P 24 B4 MX	2361539, 2361653, 2361657, 2412767, 2412768, 2412769	



Hilti Aktiengesellschaft
9494 Schaan, Liechtenstein
P +423-234 2965

www.facebook.com/hiltigroup
www.hilti.group



X-P B4 MX

Nägel für Beton

Datenblatt

[Deutsch](#)

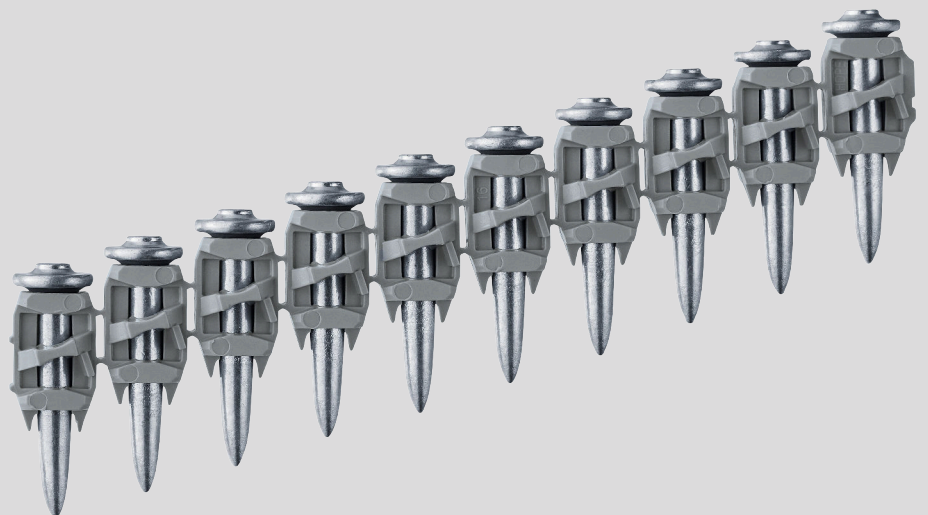

25.08.2025

INHALTSVERZEICHNIS

1	Produktinformationen	2
1.1	Produktbeschreibung	2
2	Vorgesehene Verwendung	2
2.1	Befestigungsbedingungen	2
2.2	Untergrundmaterial	2
2.3	Lastbedingungen	2
2.4	Umgebungsbedingungen	3
3	Zulassungen und Zertifizierungen	3
4	Produktdaten	3
4.1	Abmessungen	3
4.2	Materialeigenschaften für Teile aus Kohlenstoffstahl	3
4.3	Materialeigenschaften für Kunststoffteile	4
5	Systemempfehlung	4
5.1	Geräteempfehlung	4
6	Anforderungen an die vorgesehene Verwendung	4
6.1	Eigenschaften des befestigten Materials	4
6.2	Eigenschaften des Untergrundmaterials	5
6.3	Empfehlung zur Länge von Nägeln	5
7	Leistungsdaten	6
7.1	Empfohlene Lasten unter quasi-statischer Belastung	6
7.2	Erwartete Setzrate	6
8	Qualitätssicherung	7
8.1	Befestigungskontrolle	7
9	Bestellinformationen	7
9.1	Artikelnummer und Beschreibung	7

1 PRODUKTINFORMATIONEN

1.1 Produktbeschreibung

Bezeichnung	Besondere Eigenschaften
X-P B4 MX	 <ul style="list-style-type: none"> • Hochleistungsnagel für weichen und harten Beton • Lange, konische Spitze und hohe Härte – für hervorragende Befestigungsqualität

2 VORGEGEHENE VERWENDUNG

2.1 Befestigungsbedingungen

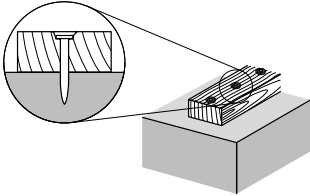
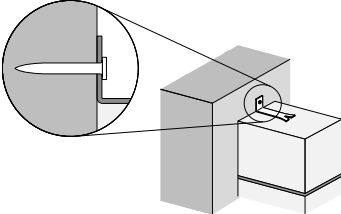
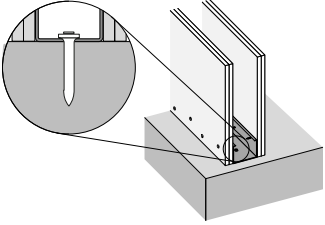
		
Holz auf Beton	Stahl auf Beton	Feste Profilbefestigung

2.2 Untergrundmaterial

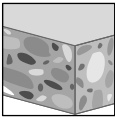
Beton

2.3 Lastbedingungen

Statisch/quasi-statisch

2.4 Umgebungsbedingungen

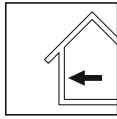

Trockene Innenräume



- Weitere Einzelheiten entnehmen Sie bitte dem [Hilti Korrosionshandbuch](#).

3 ZULASSUNGEN UND ZERTIFIZIERUNGEN

Behörde	Zulassungs-/Bescheinigungsnummer	Ausgabedatum
Deutsches Institut für Bautechnik (DIBt)	ETA-20/0886	07.07.2024



- Weitere Informationen entnehmen Sie bitte der Zulassung/Bescheinigung.
- Nicht alle in diesem Produktdatenblatt enthaltenen Informationen können Gegenstand von Zulassungen/Zertifikaten sein.
- Die in diesem Produktdatenblatt enthaltenen Informationen können auch auf den technischen Daten von Hilti beruhen.
- Zulassungen und Zertifizierungen gültig für: X-P 17 B4 MX, X-P 20 B4 MX.

4 PRODUKTDATEN

4.1 Abmessungen

Technische Zeichnung	Befestigungselement	Kopflänge	Schaftlänge	Schaftdurchmesser	Kopfdurchmesser
		L_h [mm]	L_s [mm]	d_s [mm]	d_h [mm]
	X-P 17 B4 MX	1,8	17	3	6,8
	X-P 20 B4 MX	1,8	20	3	6,8
	X-P 24 B4 MX	1,8	24	3	6,8

4.2 Materialeigenschaften für Teile aus Kohlenstoffstahl

Befestigungselement	Bauteil	Material	Beschichtung	Beschichtungsdicke	Härte	Korrosionskategorie
				t_c [μm]	[HRC]	
X-P B4 MX	Nagel	Kohlenstoffstahl	Verzinkt	≥5	57,5	C1



- Kategorie der umgebungsbedingten Korrosivität nach EN ISO 9223.

4.3 Materialeigenschaften für Kunststoffteile

Befestigungselement	Bauteil	Material	Farbe
X-P B4 MX	Streifenmagazin	HDPE (High Density Polyethylen)	Grau

5 SYSTEMEMPFEHLUNG

5.1 Geräteempfehlung

Befestigungsbedingung	Befestigungselement	Gerätetyp
Holz auf Beton, Stahl auf Beton, Feste Profilbefestigung	X-P B4 MX	BX 4-22 (01)



- Für weitere Einzelheiten wird auf das Kapitel „Kompatibilität von Zubehör und Verbrauchsmaterialien“ im [Handbuch der Direktbefestigungstechnik \(DFTM\)](#) verwiesen.

6 ANFORDERUNGEN AN DIE VORGEGEHENE VERWENDUNG

6.1 Eigenschaften des befestigten Materials

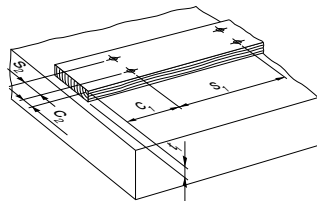

Holz auf Beton

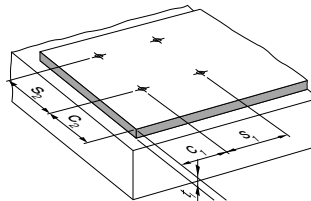

Stahl auf Beton

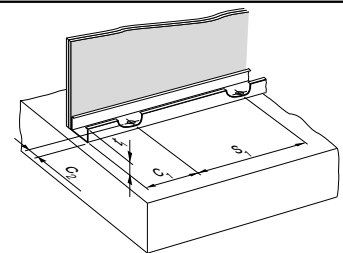

Feste Profilbefestigung

Befestigungsbedingung	Befestigungselement	Befestigtes Material	Stärke des befestigten Materials	Randabstand	Randabstand	Abstände zwischen Befestigungselementen	Abstände zwischen Befestigungselementen
			t_1 [mm]	c_1 [mm]	c_2 [mm]	s_1 [mm]	s_2 [mm]
Holz auf Beton	X-P B4 MX	Holz	≤ 25	≥ 100	≥ 22	180 – 800	≥ 80
Stahl auf Beton	X-P B4 MX	Stahl	≤ 2	≥ 40		≥ 600	≥ 80
Feste Profilbefestigung	X-P B4 MX	Stahlprofil	≤ 1	≥ 40		≤ 600	≥ 80



- Abstände für Trennwände mit Feuerwiderstand: 300 mm.

6.2 Eigenschaften des Untergrundmaterials

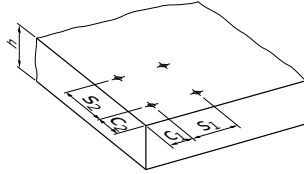

Befestigung an Beton

Untergrundmaterial	Dicke des Untergrundmaterials	Randabstand	Randabstand	Abstände zwischen Befestigungselementen	Abstände zwischen Befestigungselementen
	h [mm]	c ₁ [mm]	c ₂ [mm]	s ₁ [mm]	s ₂ [mm]
Beton	≥ 60	≥ 70	≥ 70	≥ 100	≥ 80

6.3 Empfehlung zur Länge von Nägeln

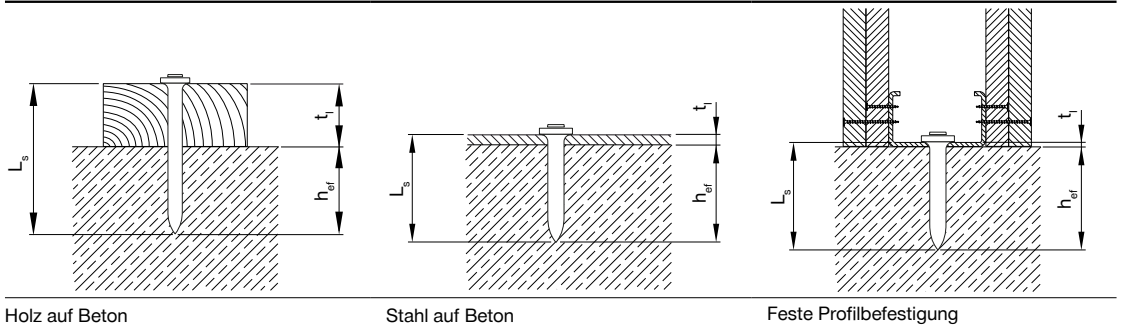

Befestigungsbedingung	Befestigungsmerkmale	Schaftlänge	Verankerungstiefe	Stärke des befestigten Materials
		L _s [mm]	h _{ef} [mm]	t _i [mm]
Holz auf Beton	Standardbefestigung	$L_s \geq h_{ef} + t_i$	≥ 14	≤ 25
	Bündige Befestigung	$L_s \geq h_{ef} + t_i - 3$	≥ 14	≤ 25
Stahl auf Beton	Standardbefestigung	$L_s \geq h_{ef} + t_i$	≥ 11	≤ 2
Feste Profilbefestigung	Standardbefestigung	$L_s \geq h_{ef} + t_i$	≥ 11	≤ 1

7 LEISTUNGSDATEN

7.1 Empfohlene Lasten unter quasi-statischer Belastung

Befestigungsbedingung	Befestigungselement	Untergrundmaterial	Verankerungstiefe	Zuglast	Querkraft
			h_{ef} [mm]	N_{rec} [kN]	V_{rec} [kN]
Holz auf Beton	X-P B4 MX	Weicher Beton, Mittelfester Beton, Harter Beton	14 - < 18	0,1	0,1
		Weicher Beton, Mittelfester Beton	≥ 18	0,2	0,2
Weicher Beton, Mittelfester Beton, Harter Beton		11 - < 14	0,1	0,38	
Weicher Beton, Mittelfester Beton, Harter Beton		14 - < 18	0,1	0,38	
Weicher Beton, Mittelfester Beton		≥ 18	0,2	0,38	
Stahl auf Beton, Feste Profilbefestigung					



- Redundanz für Befestigungspunkte ist erforderlich.
- Mindestanzahl Befestigungspunkte für sicherheitsrelevante Befestigungen: ≥ 5 .

7.2 Erwartete Setzrate

Technische Zeichnung	Befestigungsbedingung	Untergrundmaterial	Erwartete Setzrate [%]
	Stahl auf Beton, Holz auf Beton, Feste Profilbefestigung	Weicher Beton	85 - 98
		Mittelfester Beton	85 - 98
		Harter Beton	70 - 85



- Die Setzrate kann je nach Baustellenbedingungen von den oben genannten Werten abweichen.
- Die Setzrate gibt den Anteil der Nägel an, die korrekt eingetrieben wurden, um eine Last zu tragen.

8 QUALITÄTSSICHERUNG

8.1 Befestigungskontrolle

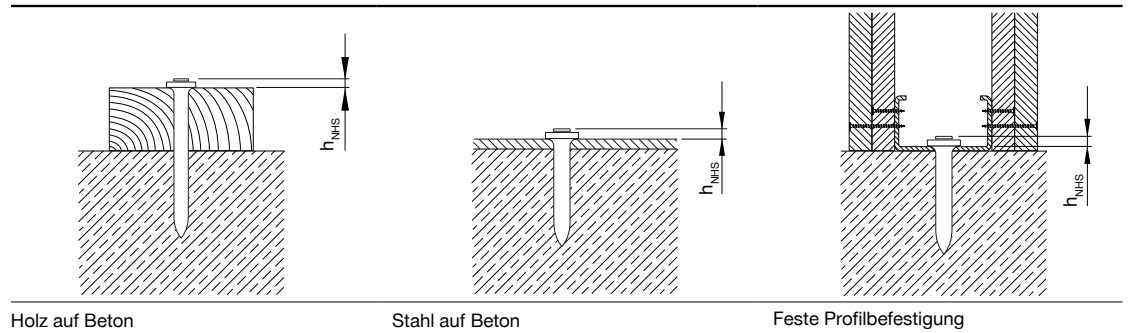

Befestigungsbedingung	Befestigungselement	Bolzenvorstand h_{NHS} [mm]
Holz auf Beton	X-P B4 MX	≤ 3
Stahl auf Beton, Feste Profilbefestigung	X-P B4 MX	2 – 5



- Sichtbare Montagefehler sind durch ein neues Befestigungselement zu ersetzen.
- Dies ist eine gekürzte Fassung der Bedienungsanleitung. Der Wortlaut kann je nach Anwendung unterschiedlich sein.
- Beachten Sie immer die dem Produkt beiliegenden Anweisungen.

9 BESTELLINFORMATIONEN

9.1 Artikelnummer und Beschreibung

Bezeichnung	Artikelnummer	Beschreibung
X-P 17 B4 MX	2361537, 2361651, 2361655, 2412761, 2412762, 2412763	X-P B4 MX Nägel für Beton (magaziniert)
X-P 20 B4 MX	2361538, 2361652, 2361656, 2412764, 2412765, 2412766	
X-P 24 B4 MX	2361539, 2361653, 2361657, 2412767, 2412768, 2412769	



Hilti Aktiengesellschaft
9494 Schaan, Liechtenstein
P +423-234 2965

www.facebook.com/hiltigroup
www.hilti.group



X-P B4 MX

Clous béton

Fiche technique

[Français](#)

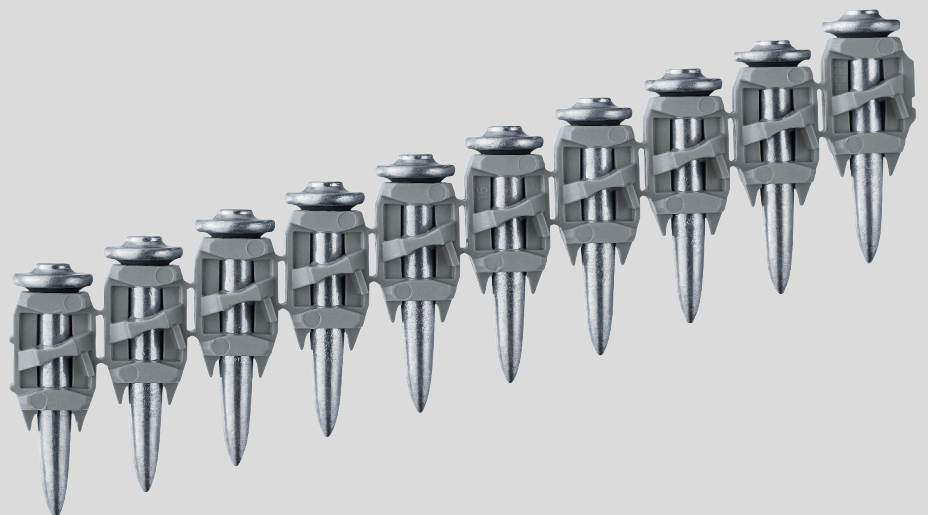

25 août 2025

TABLE DES MATIÈRES

1	Informations sur le produit	2
1.1	Description du produit	2
2	Utilisation prévue	2
2.1	Conditions de fixation	2
2.2	Matériaux supports	2
2.3	Conditions de charge	2
2.4	Conditions environnementales	3
3	Homologations et certificats	3
4	Données produit	3
4.1	Dimensions	3
4.2	Propriétés du matériau pour pièces en acier au carbone	3
4.3	Propriétés du matériau pour pièces plastiques	4
5	Recommandation système	4
5.1	Recommandation sur l'outil	4
6	Exigences pour l'utilisation prévue	4
6.1	Propriétés du matériau fixé	4
6.2	Propriétés du matériau support	5
6.3	Longueur de clou recommandée	5
7	Données de performance	6
7.1	Charges recommandées sous les charges quasi statiques	6
7.2	Estimation du taux de réussite	6
8	Assurance qualité	7
8.1	Contrôle de la fixation	7
9	Informations de commande	7
9.1	Numéro d'article et description	7

1 INFORMATIONS SUR LE PRODUIT

1.1 Description du produit

Désignation	Caractéristiques
X-P B4 MX	 <ul style="list-style-type: none"> • Clou très haute performance pour le béton léger et certains bétons durs • Pointe de conique long et dureté élevée - pour une fixation de grande qualité

2 UTILISATION PRÉVUE

2.1 Conditions de fixation

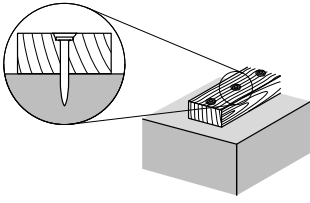
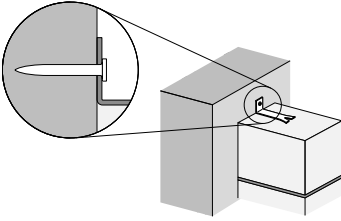
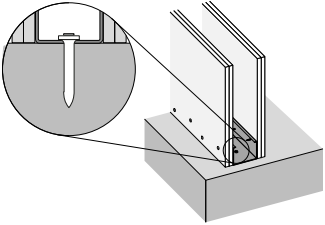
		
Bois sur béton	Acier sur béton	Fixation du rail fixe

2.2 Matériaux supports

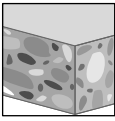
Béton

2.3 Conditions de charge

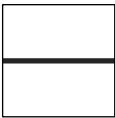
Statique/quasi statique

2.4 Conditions environnementales

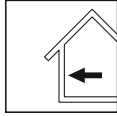

Milieu intérieur sec



- Pour de plus amples informations, veuillez vous reporter à [manuel sur la corrosion Hilti](#).

3 HOMOLOGATIONS ET CERTIFICATS

Autorité	N° d'homologation/de certificat	Date d'émission
Deutsches Institut für Bautechnik (DIBt)	ETA-20/0886	7 juil. 2024



- Veuillez vous reporter à l'homologation/au certificat pour obtenir de plus amples informations.
- Les informations présentées dans cette fiche produit ne font pas forcément toutes l'objet d'une homologation ou d'un certificat.
- Les informations présentées dans cette fiche technique peuvent également être basées sur les données techniques Hilti.
- Homologations et certificats valides pour : X-P 17 B4 MX, X-P 20 B4 MX.

4 DONNÉES PRODUIT

4.1 Dimensions

Dessin technique	Fixation	Longueur de tête	Longueur de la tige	Diamètre de la tige	Diamètre de tête
		L_h [mm]	L_s [mm]	d_s [mm]	d_h [mm]
	X-P 17 B4 MX	1,8	17	3	6,8
	X-P 20 B4 MX	1,8	20	3	6,8
	X-P 24 B4 MX	1,8	24	3	6,8

4.2 Propriétés du matériau pour pièces en acier au carbone

Fixation	Pièce de composant	Matériau	Revêtements	Épaisseur du revêtement	Dureté	Catégorie de corrosivité
				t_c [μm]	[HRC]	
X-P B4 MX	Clou	Acier au carbone	Recouvert de zinc	≥5	57,5	C1



- Catégorie de corrosivité de l'atmosphère selon la norme EN ISO 9223.

4.3 Propriétés du matériau pour pièces plastiques

Fixation	Pièce de composant	Matériau	Couleur
X-P B4 MX	Magasin à bandes	Polyéthylène haute densité (HDPE)	Gris

5 RECOMMANDATION SYSTÈME

5.1 Recommandation sur l'outil

Conditions de fixation	Fixation	Type d'outil
Bois sur béton, Acier sur béton, Fixation du rail fixe	X-P B4 MX	BX 4-22 (01)



- Pour plus de détails, veuillez vous reporter au chapitre sur la compatibilité des accessoires et des consommables dans le [Guide sur la technologie de clouage \(DFTM\)](#).

6 EXIGENCES POUR L'UTILISATION PRÉVUE

6.1 Propriétés du matériau fixé

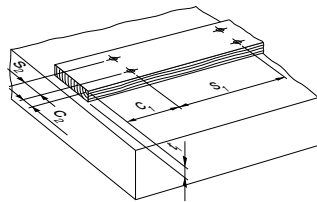

Bois sur béton

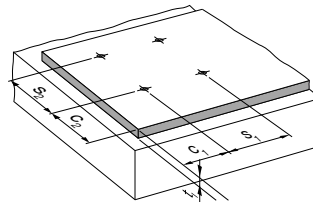

Acier sur béton

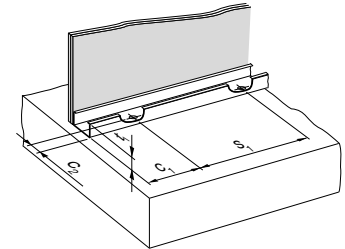

Fixation du rail fixe

Conditions de fixation	Fixation	Matériau fixé	Épaisseur du matériau fixé	Distance au bord	Distance au bord	Distance d'écartement entre les fixations	Distance d'écartement entre les fixations
			t ₁ [mm]	c ₁ [mm]	c ₂ [mm]	s ₁ [mm]	s ₂ [mm]
Bois sur béton	X-P B4 MX	Bois	≤ 25	≥ 100	≥ 22	180 – 800	≥ 80
Acier sur béton	X-P B4 MX	Acier	≤ 2	≥ 40		≥ 600	≥ 80
Fixation du rail fixe	X-P B4 MX	Rail en acier	≤ 1	≥ 40		≤ 600	≥ 80



- Espacement pour cloisons avec résistance au feu : 300 mm.

6.2 Propriétés du matériau support

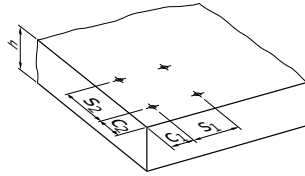

Fixation au béton

Matériau support	Épaisseur du matériau support h [mm]	Distance au bord c ₁ [mm]	Distance au bord c ₂ [mm]	Distance d'écartement entre les fixations s ₁ [mm]	Distance d'écartement entre les fixations s ₂ [mm]
Béton	≥ 60	≥ 70	≥ 70	≥ 100	≥ 80

6.3 Longueur de clou recommandée

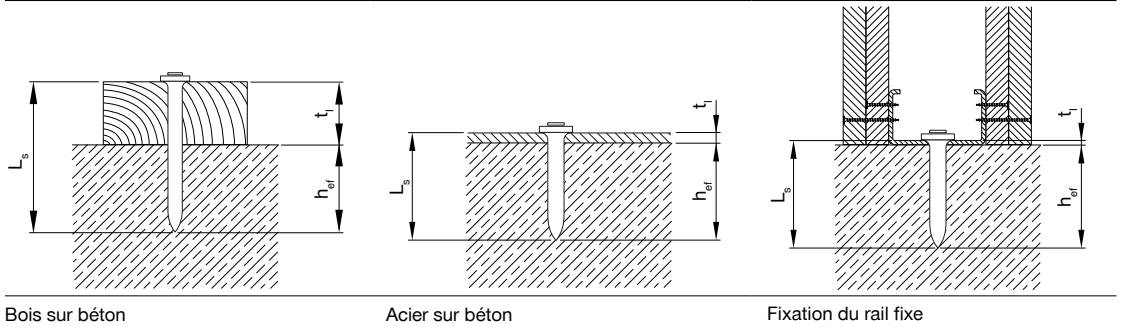

Conditions de fixation	Caractéristiques de fixation	Longueur de tige	Profondeur d'implantation	Épaisseur du matériau fixé
		L _s [mm]	h _{ef} [mm]	t _i [mm]
Bois sur béton	Fixation standard	$L_s \geq h_{ef} + t_i$	≥ 14	≤ 25
	Fixation à ras	$L_s \geq h_{ef} + t_i - 3$	≥ 14	≤ 25
Acier sur béton	Fixation standard	$L_s \geq h_{ef} + t_i$	≥ 11	≤ 2
Fixation du rail fixe	Fixation standard	$L_s \geq h_{ef} + t_i$	≥ 11	≤ 1

7 DONNÉES DE PERFORMANCE

7.1 Charges recommandées sous les charges quasi statiques

Conditions de fixation	Fixation	Type de matériau support	Profondeur d'implantation	Charge de traction	Charge de cisaillement
			h_{ef} [mm]	N_{rec} [kN]	V_{rec} [kN]
Bois sur béton	X-P B4 MX	Béton léger, Béton moyen, Béton dur	14 - < 18	0,1	0,1
		Béton léger, Béton moyen	≥ 18	0,2	0,2
Béton léger, Béton moyen, Béton dur		11 - < 14	0,1	0,38	
Fixation du rail fixe, Acier sur béton		Béton léger, Béton moyen, Béton dur	14 - < 18	0,1	0,38
		Béton léger, Béton moyen	≥ 18	0,2	0,38



- La redondance des points de fixation est requise.
- Nombre minimum de points de fixation pour les fixations de sécurité : ≥ 5 .

7.2 Estimation du taux de réussite

Dessin technique	Conditions de fixation	Type de matériau support	Estimation du taux de réussite
			[%]
	Fixation du rail fixe, Bois sur béton, Acier sur béton	Béton léger	85-98
		Béton moyen	85-98
		Béton dur	70-85



- Le taux de réussite peut varier par rapport aux valeurs ci-dessus en fonction des conditions du chantier.
- Le taux de réussite indique le pourcentage de clous qui ont été enfoncés correctement pour porter une charge.

8 ASSURANCE QUALITÉ

8.1 Contrôle de la fixation

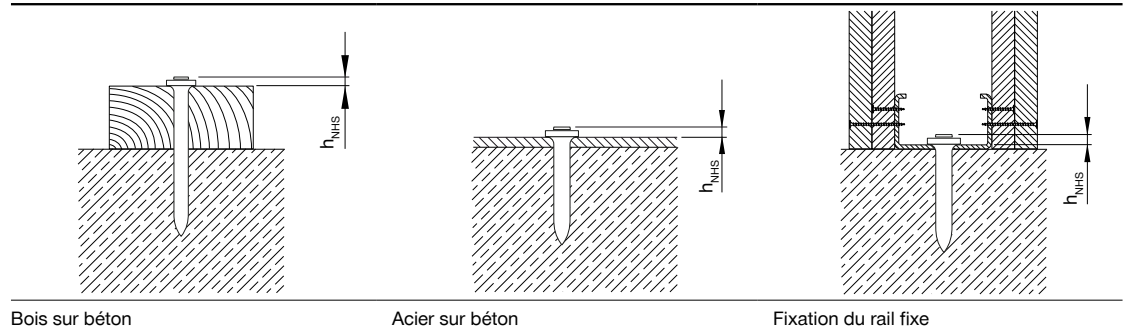

Conditions de fixation	Fixation	Implantation de la fixation h_{NHS} [mm]
Bois sur béton	X-P B4 MX	≤ 3
Acier sur béton, Fixation du rail fixe	X-P B4 MX	2-5



- Les erreurs de pose visibles doivent être corrigées en réalisant une nouvelle fixation, avec un nouveau trou.
- Ces instructions abrégées peuvent varier selon l'application.
- Toujours consulter / suivre les instructions qui accompagnent le produit.

9 INFORMATIONS DE COMMANDE

9.1 Numéro d'article et description

Désignation	Code article	Description
X-P 17 B4 MX	2361537, 2361651, 2361655, 2412761, 2412762, 2412763	Clous X-P B4 MX béton (en bande)
X-P 20 B4 MX	2361538, 2361652, 2361656, 2412764, 2412765, 2412766	
X-P 24 B4 MX	2361539, 2361653, 2361657, 2412767, 2412768, 2412769	



Hilti Aktiengesellschaft
9494 Schaan, Liechtenstein
P +423-234 2965

www.facebook.com/hiltigroup
www.hilti.group



X-P B4 MX

Clavos para hormigón

Hoja de datos

[Español](#)

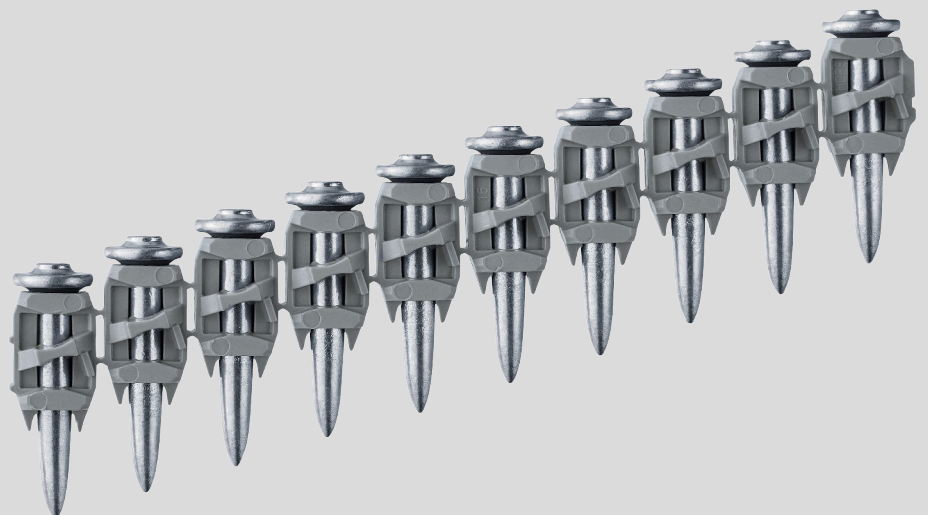

25 ago. 2025

ÍNDICE

1	Información del producto	2
1.1	Descripción del producto	2
2	Uso previsto	2
2.1	Condiciones de fijación	2
2.2	Materiales base	2
2.3	Condiciones de carga	2
2.4	Condiciones ambientales	3
3	Homologaciones y certificados	3
4	Datos del producto	3
4.1	Dimensiones	3
4.2	Propiedades del material para piezas de acero al carbono	3
4.3	Propiedades del material para piezas de plástico	4
5	Recomendación del sistema	4
5.1	Recomendación de herramienta	4
6	Requisitos para el uso previsto	4
6.1	Propiedades del material de fijación	4
6.2	Propiedades del material base	5
6.3	Recomendación de longitud de clavo	5
7	Datos de rendimiento	6
7.1	Cargas recomendadas con carga cuasiestática	6
7.2	Estimación de ratio de fijación correcta	6
8	Control de calidad	7
8.1	Inspección de fijación	7
9	Información del pedido	7
9.1	Número y descripción del artículo	7

1 INFORMACIÓN DEL PRODUCTO

1.1 Descripción del producto

Designación	Características
X-P B4 MX	 <ul style="list-style-type: none"> • Clavo de máximo rendimiento para hormigón blando y determinados hormigones duros • Punta larga, cónica y de alta dureza para una excelente calidad de la fijación

2 USO PREVISTO

2.1 Condiciones de fijación

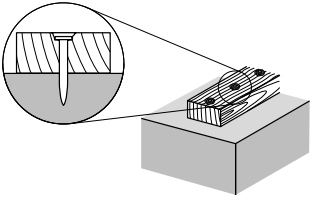
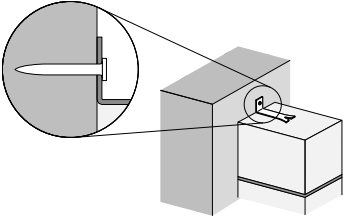
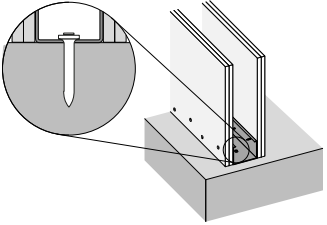
		
Madera a hormigón	Acero a hormigón	Fijación de perfiles fija

2.2 Materiales base

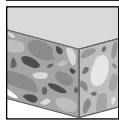

Hormigón

2.3 Condiciones de carga



Estática y cuasiestática

2.4 Condiciones ambientales

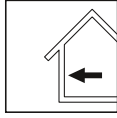

Interior seco



- Para obtener más información, consulte [Manual de corrosión de Hilti](#).

3 HOMOLOGACIONES Y CERTIFICADOS

Autoridad	Número de homologación/certificado	Fecha de emisión
Deutsches Institut für Bautechnik (DIBt)	ETA-20/0886	7 jul. 2024



- Para obtener más información, consulte el certificado o la homologación.
- Es posible que no toda la información que se proporciona en esta hoja de datos del producto esté sujeta al contenido del certificado u homologación.
- La información que se presenta en esta hoja de datos del producto también puede basarse en los datos técnicos de Hilti.
- Homologaciones y certificados válidos para: X-P 17 B4 MX, X-P 20 B4 MX.

4 DATOS DEL PRODUCTO

4.1 Dimensiones

Dibujo técnico	Fijación	Longitud de cabeza	Longitud del vástago	Diámetro de vástago	Diámetro de la cabeza
		L_h [mm]	L_s [mm]	d_s [mm]	d_h [mm]
	X-P 17 B4 MX	1,8	17	3	6,8
	X-P 20 B4 MX	1,8	20	3	6,8
	X-P 24 B4 MX	1,8	24	3	6,8

4.2 Propiedades del material para piezas de acero al carbono

Fijación	Pieza de componente	Material	Revestimiento	Espesor del revestimiento t_c [μm]	Dureza [HRC]	Categoría de corrosión
X-P B4 MX	Clavo	Acero al carbono	Con revestimiento de zinc	≥5	57,5	C1

- Categoría de corrosión de la atmósfera según la norma EN ISO 9223.

4.3 Propiedades del material para piezas de plástico

Fijación	Pieza de componente	Material	Color
X-P B4 MX	Cargador de tiras	Poliétileno de alta densidad (HDPE)	Gris

5 RECOMENDACIÓN DEL SISTEMA

5.1 Recomendación de herramienta

Condición de fijación	Fijación	Tipo de herramienta
Madera a hormigón, Acero a hormigón, Fijación de perfiles fija	X-P B4 MX	BX 4-22 (01)

- Para obtener más detalles, consulte el capítulo sobre la compatibilidad de accesorios y consumibles en el [Manual de tecnología de fijación directa \(DFTM\)](#).

6 REQUISITOS PARA EL USO PREVISTO

6.1 Propiedades del material de fijación

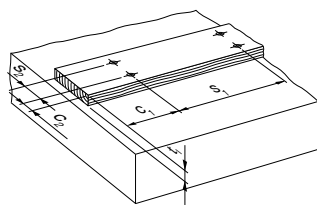

Madera a hormigón

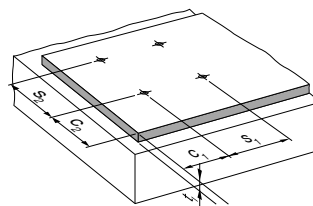

Acero a hormigón

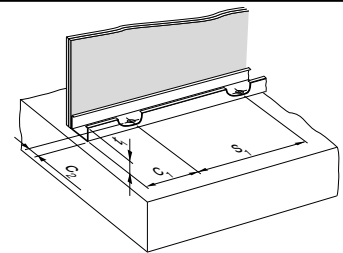

Fijación de perfiles fija

Condición de fijación	Fijación	Material de fijación	Esesor del material fijado	Distancia al borde	Distancia al borde	Distancia de separación de la fijación	Distancia de separación de la fijación
			t ₁ [mm]	c ₁ [mm]	c ₂ [mm]	s ₁ [mm]	s ₂ [mm]
Madera a hormigón	X-P B4 MX	Madera	≤ 25	≥ 100	≥ 22	180 – 800	≥ 80
Acero a hormigón	X-P B4 MX	Acero	≤ 2	≥ 40		≥ 600	≥ 80
Fijación de perfiles fija	X-P B4 MX	Carril de acero	≤ 1	≥ 40		≤ 600	≥ 80

- Espaciado para muros de partición con clasificación de resistencia al fuego: 300 mm.

6.2 Propiedades del material base

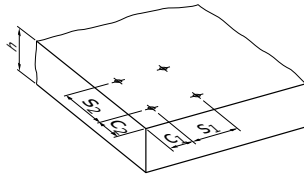

Fijación a hormigón

Material base	Espesor del material base	Distancia al borde	Distancia al borde	Distancia de separación de la fijación	Distancia de separación de la fijación
	h [mm]	c_1 [mm]	c_2 [mm]	s_1 [mm]	s_2 [mm]
Hormigón	≥ 60	≥ 70	≥ 70	≥ 100	≥ 80

6.3 Recomendación de longitud de clavo

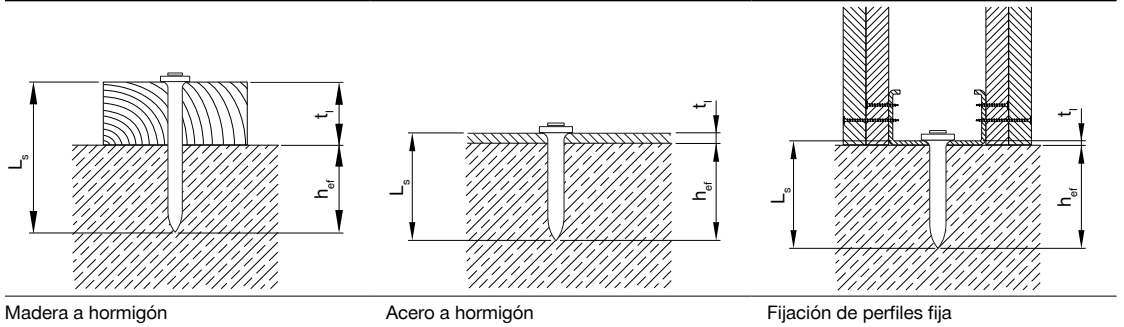

Madera a hormigón

Acero a hormigón

Fijación de perfiles fija

Condición de fijación	Características de fijación	Longitud del vástago	Profundidad de empotramiento	Espesor del material fijado
		L_s [mm]	h_{ef} [mm]	t_i [mm]
Madera a hormigón	Fijación estándar	$L_s \geq h_{ef} + t_i$	≥ 14	≤ 25
	Fijación a ras	$L_s \geq h_{ef} + t_i - 3$	≥ 14	≤ 25
Acero a hormigón	Fijación estándar	$L_s \geq h_{ef} + t_i$	≥ 11	≤ 2
Fijación de perfiles fija	Fijación estándar	$L_s \geq h_{ef} + t_i$	≥ 11	≤ 1

7 DATOS DE RENDIMIENTO

7.1 Cargas recomendadas con carga cuasiestática

Condición de fijación	Fijación	Tipo de material base	Profundi- dad de empotra- miento	Carga de tensión	Carga cortante
			h_{ef} [mm]	N_{rec} [kN]	V_{rec} [kN]
Madera a hormigón	X-P B4 MX	Hormigón blando, Hormigón medio, Hormigón duro	14 - < 18	0,1	0,1
		Hormigón blando, Hormigón medio	≥ 18	0,2	0,2
Hormigón blando, Hormigón medio, Hormigón duro		11 - < 14	0,1	0,38	
Fijación de perfiles fija, Acero a hormigón		Hormigón blando, Hormigón medio, Hormigón duro	14 - < 18	0,1	0,38
		Hormigón blando, Hormigón medio	≥ 18	0,2	0,38



- Se requiere redundancia de puntos de fijación.
- Número mínimo de puntos de fijación para fijaciones en las que la seguridad es importante: ≥ 5 .

7.2 Estimación de ratio de fijación correcta

Dibujo técnico	Condición de fijación	Tipo de material base	Estimación de ratio de fijación correcta [%]
	Madera a hormigón, Fijación de perfiles fija, Acero a hormigón	Hormigón blando	85 - 98
		Hormigón medio	85 - 98
		Hormigón duro	70 - 85



- El ratio de fijación correcta puede variar de los valores anteriores en función de las condiciones del lugar de trabajo.
- La tasa de fijación indica el porcentaje de clavos que se colocaron correctamente para soportar una carga.

8 CONTROL DE CALIDAD

8.1 Inspección de fijación

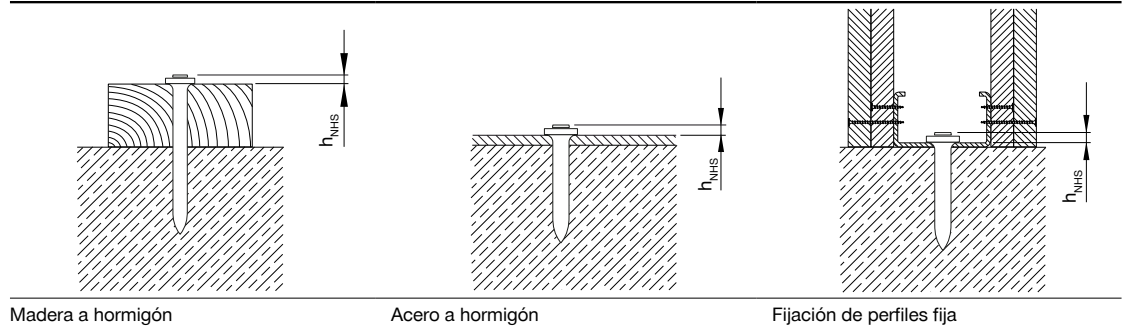

Condición de fijación	Fijación	Fijación con distanciador h _{NHS} [mm]
Madera a hormigón	X-P B4 MX	≤ 3
Acero a hormigón, Fijación de perfiles fija	X-P B4 MX	2 – 5



- Los fallos de colocación visibles deben sustituirse por nuevas fijaciones, sin utilizar el mismo orificio.
- Estas instrucciones se encuentran abreviadas y pueden variar según la aplicación.
- Revise y siga siempre las instrucciones que acompañan al producto.

9 INFORMACIÓN DEL PEDIDO

9.1 Número y descripción del artículo

Designación	Número de elemento	Descripción
X-P 17 B4 MX	2361537, 2361651, 2361655, 2412761, 2412762, 2412763	Clavos para hormigón X-P B4 MX (en tiras)
X-P 20 B4 MX	2361538, 2361652, 2361656, 2412764, 2412765, 2412766	
X-P 24 B4 MX	2361539, 2361653, 2361657, 2412767, 2412768, 2412769	



Hilti Aktiengesellschaft
9494 Schaan, Liechtenstein
P +423-234 2965

www.facebook.com/hiltigroup
www.hilti.group



X-P B4 MX

Chiodi per calcestruzzo

Scheda tecnica

[Italiano](#)

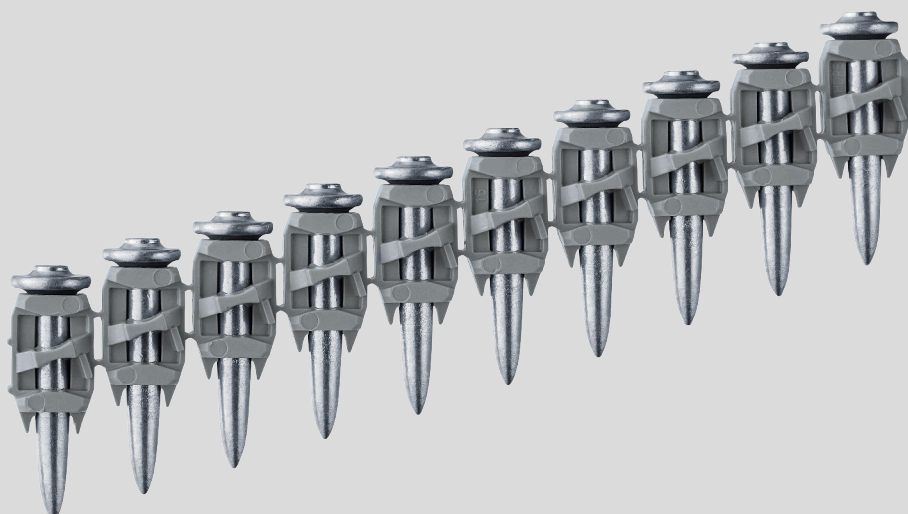

25 ago 2025

INDICE

1	Informazioni sul prodotto	2
1.1	Descrizione del prodotto	2
2	Uso previsto	2
2.1	Condizioni di fissaggio	2
2.2	Materiali di base	2
2.3	Condizioni di carico	2
2.4	Condizioni ambientali	3
3	Omologazioni e certificazioni	3
4	Dati del prodotto	3
4.1	Dimensioni	3
4.2	Proprietà dei materiali per parti in acciaio al carbonio	3
4.3	Proprietà dei materiali per parti in plastica	4
5	Raccomandazioni sul sistema	4
5.1	Raccomandazioni per l'attrezzo	4
6	Requisiti per l'uso previsto	4
6.1	Caratteristiche del materiale fissato	4
6.2	Proprietà del materiale di base	5
6.3	Lunghezza del chiodo consigliata	5
7	Dati sulle prestazioni	6
7.1	Carichi raccomandati in caso carico quasi statico	6
7.2	Stima del tasso di trucioli	6
8	Assicurazione qualità	7
8.1	Ispezione fissaggio	7
9	Informazioni per l'ordine	7
9.1	Numero articolo e descrizione	7

1 INFORMAZIONI SUL PRODOTTO

1.1 Descrizione del prodotto

Denominazione	Vantaggi
X-P B4 MX	<ul style="list-style-type: none"> • Chiodo ad alte prestazioni per calcestruzzo morbido e alcuni tipi di calcestruzzo duro • Punta lunga, conica e alta durezza – per un'eccellente qualità di fissazione



2 USO PREVISTO

2.1 Condizioni di fissaggio

Legno su calcestruzzo	Acciaio su calcestruzzo	Fissaggio guida fissa

2.2 Materiali di base

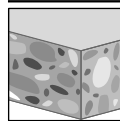

Calcestruzzo

2.3 Condizioni di carico

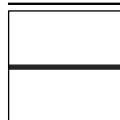

Statico/quasi statico

2.4 Condizioni ambientali

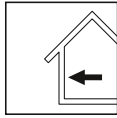

Interni asciutti



- Per maggiori dettagli, fare riferimento a [Hilti Corrosion Handbook](#) (Manuale sulla corrosione Hilti).

3 OMOLOGAZIONI E CERTIFICAZIONI

Autorità	N. omologazione/certificazione	Data di emissione
Deutsches Institut für Bautechnik (DIBt)	ETA-20/0886	07 lug 2024



- Per ulteriori informazioni fare riferimento all'omologazione/certificazione corrispondente.
- Non tutte le informazioni presentate in questa scheda tecnica del prodotto possono essere soggette a omologazione/certificazione.
- Le informazioni contenute in questa scheda tecnica possono anche essere basate sui dati tecnici Hilti.
- Omologazioni e certificazioni valide per: X-P 17 B4 MX, X-P 20 B4 MX.

4 DATI DEL PRODOTTO

4.1 Dimensioni

Disegno tecnico	Elemento di fissaggio	Lunghezza testa	Lunghezza gambo	Diametro gambo	Diametro testa
		L_h [mm]	L_s [mm]	d_s [mm]	d_h [mm]
	X-P 17 B4 MX	1,8	17	3	6,8
	X-P 20 B4 MX	1,8	20	3	6,8
	X-P 24 B4 MX	1,8	24	3	6,8

4.2 Proprietà dei materiali per parti in acciaio al carbonio

Elemento di fissaggio	Parte del componente	Materiale	Rivestimento	Spessore di rivestimento t_c [μm]	Durezza [HRC]	Categoria di corrosività
X-P B4 MX	Chiodo	Acciaio al carbonio	Zincato	≥5	57,5	C1



- Categoria di corrosività dell'atmosfera secondo EN ISO 9223.

4.3 Proprietà dei materiali per parti in plastica

Elemento di fissaggio	Parte del componente	Materiale	Colore
X-P B4 MX	Magazzino a strisce	Polietilene ad alta densità (HDPE)	Grigio

5 RACCOMANDAZIONI SUL SISTEMA

5.1 Raccomandazioni per l'attrezzo

Condizione di fissaggio	Elemento di fissaggio	Tipo di attrezzo
Legno su calcestruzzo, Acciaio su calcestruzzo, Fissaggio guida fissa	X-P B4 MX	BX 4-22 (01)

- i** • Per maggiori dettagli, fare riferimento al capitolo Compatibilità di accessori e materiali di consumo all'indirizzo [Direct Fastening Technology Manual \(DFTM\)](#) (Manuale del fissaggio diretto).

6 REQUISITI PER L'USO PREVISTO

6.1 Caratteristiche del materiale fissato

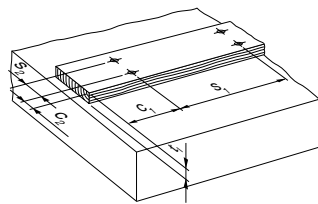

Legno su calcestruzzo

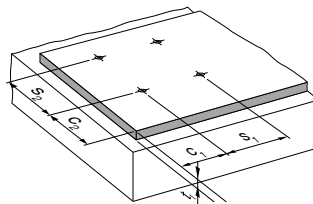

Acciaio su calcestruzzo

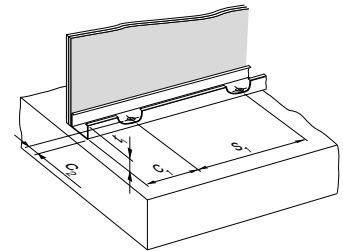

Fissaggio guida fissa

Condizione di fissaggio	Elemento di fissaggio	Materiale fissato	Spessore materiale fissato	Distanza dal bordo	Distanza dal bordo	Distanza dall'elemento di fissaggio	Distanza dall'elemento di fissaggio
			t_1 [mm]	c_1 [mm]	c_2 [mm]	s_1 [mm]	s_2 [mm]
Legno su calcestruzzo	X-P B4 MX	Legno	≤ 25	≥ 100	≥ 22	180–800	≥ 80
Acciaio su calcestruzzo	X-P B4 MX	Acciaio	≤ 2	≥ 40		≥ 600	≥ 80
Fissaggio guida fissa	X-P B4 MX	Binari d'acciaio	≤ 1	≥ 40		≤ 600	≥ 80

- i** • Spaziatura per pareti di partizione con resistenza al fuoco: 300 mm.

6.2 Proprietà del materiale di base

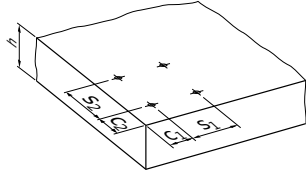

Fissaggio su calcestruzzo

Materiale di base	Spessore materiale di base	Distanza dal bordo	Distanza dal bordo	Distanza dall'elemento di fissaggio	Distanza dall'elemento di fissaggio
	h [mm]	c ₁ [mm]	c ₂ [mm]	s ₁ [mm]	s ₂ [mm]
Calcestruzzo	≥ 60	≥ 70	≥ 70	≥ 100	≥ 80

6.3 Lunghezza del chiodo consigliata

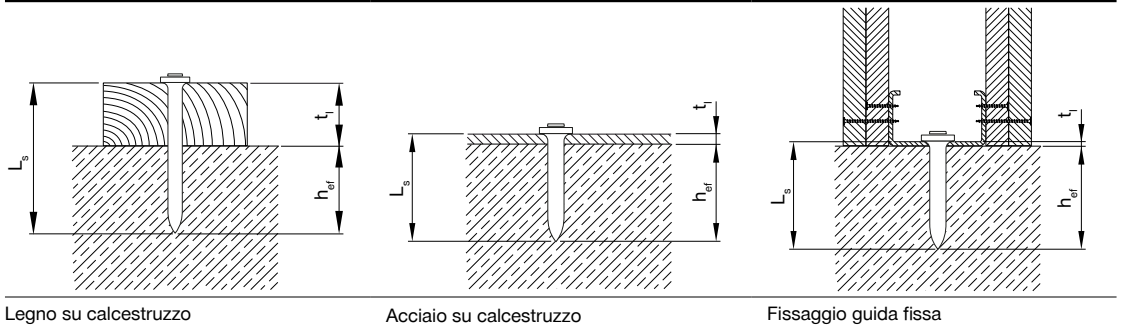

Condizione di fissaggio	Caratteristiche di fissaggio	Lunghezza gambo	Profondità di posa	Spessore materiale fissato
		L _s [mm]	h _{ef} [mm]	t _i [mm]
Legno su calcestruzzo	Fissazione standard	$L_s \geq h_{ef} + t_i$	≥ 14	≤ 25
	Fissaggio a filo	$L_s \geq h_{ef} + t_i - 3$	≥ 14	≤ 25
Acciaio su calcestruzzo	Fissazione standard	$L_s \geq h_{ef} + t_i$	≥ 11	≤ 2
Fissaggio guida fissa	Fissazione standard	$L_s \geq h_{ef} + t_i$	≥ 11	≤ 1

7 DATI SULLE PRESTAZIONI

7.1 Carichi raccomandati in caso carico quasi statico

Condizione di fissaggio	Elemento di fissaggio	Tipo di materiale base	Profondità di posa	Carico a trazione	Carico di taglio
			h_{ef} [mm]	N_{rec} [kN]	V_{rec} [kN]
Legno su calcestruzzo		Cemento morbido, Calcestruzzo medio, Calcestruzzo duro	14 - < 18	0,1	0,1
		Cemento morbido, Calcestruzzo medio	≥ 18	0,2	0,2
Fissaggio guida fissa, Acciaio su calcestruzzo	X-P B4 MX	Cemento morbido, Calcestruzzo medio, Calcestruzzo duro	11 - < 14	0,1	0,38
		Cemento morbido, Calcestruzzo medio, Calcestruzzo duro	14 - < 18	0,1	0,38
		Cemento morbido, Calcestruzzo medio	≥ 18	0,2	0,38

- È necessaria una ridondanza dei punti di fissaggio.
- Numero minimo di punti di fissaggio per fissaggi rilevanti per la sicurezza: ≥ 5 .

7.2 Stima del tasso di trucioli

Disegno tecnico	Condizione di fissaggio	Tipo di materiale base	Stima del tasso di trucioli [%]
	Legno su calcestruzzo, Fissaggio guida fissa, Acciaio su calcestruzzo	Cemento morbido	85 - 98
		Calcestruzzo medio	85 - 98
		Calcestruzzo duro	70 - 85

- Il tasso di trucioli può variare dai valori sopracitati a seconda delle condizioni in cantiere.
- Il tasso di trucioli indica la percentuale di chiodi inseriti correttamente per sostenere il carico.

8 ASSICURAZIONE QUALITÀ

8.1 Ispezione fissaggio

Legno su calcestruzzo	Acciaio su calcestruzzo	Fissaggio guida fissa
Condizione di fissaggio	Elemento di fissaggio	Distanziatore chiodo h_{NHS} [mm]
Legno su calcestruzzo	X-P B4 MX	≤ 3
Acciaio su calcestruzzo, Fissaggio guida fissa	X-P B4 MX	2 - 5



- Gli errori di impostazione evidenti devono essere corretti sostituendo l'elemento di fissaggio, realizzando un nuovo foro.
- Di seguito sono riportate istruzioni brevi che possono variare a seconda dell'applicazione.
- Consultare/seguire sempre le istruzioni allegate al prodotto.

9 INFORMAZIONI PER L'ORDINE

9.1 Numero articolo e descrizione

Denominazione	Codice articolo	Descrizione
X-P 17 B4 MX	2361537, 2361651, 2361655, 2412761, 2412762, 2412763	Chiodi per calcestruzzo X-P B4 MX (a nastro)
X-P 20 B4 MX	2361538, 2361652, 2361656, 2412764, 2412765, 2412766	
X-P 24 B4 MX	2361539, 2361653, 2361657, 2412767, 2412768, 2412769	



Hilti Aktiengesellschaft
9494 Schaan, Liechtenstein
P +423-234 2965

www.facebook.com/hiltigroup
www.hilti.group



X-P B4 MX

Gwoździe do betonu

Karta danych

Polski

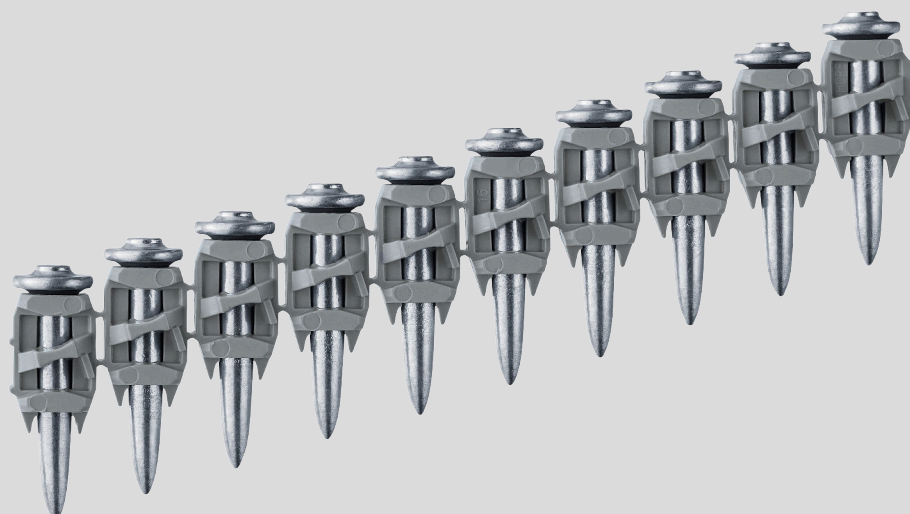

25.08.2025

SPIS TREŚCI

1	Informacje o produkcie	2
1.1	Opis produktu	2
2	Przeznaczenie	2
2.1	Warunki mocowania	2
2.2	Materiały podłoża	2
2.3	Warunki obciążenia	2
2.4	Warunki środowiskowe	3
3	Aprobaty i certyfikaty	3
4	Dane produktu	3
4.1	Wymiary	3
4.2	Właściwości materiału dla części ze stali węglowej	3
4.3	Właściwości materiału dla elementów z tworzyw sztucznych	4
5	Zalecenie systemu	4
5.1	Narzędzie polecane	4
6	Wymagania dotyczące zamierzonych zastosowań	4
6.1	Właściwości zamocowanego materiału	4
6.2	Właściwości materiału podłoża	5
6.3	Zalecana długość gwoździ	5
7	Dane właściwości	6
7.1	Zalecane obciążenia przy obciążeniu kwazistatycznym	6
7.2	Ocena współczynnika mocowania	6
8	Zapewnianie jakości	7
8.1	Inspekcja mocowania	7
9	Informacje dotyczące zamawiania	7
9.1	Nr artykułu i opis	7

1 INFORMACJE O PRODUKCIE

1.1 Opis produktu

Oznaczenie	Cechy
X-P B4 MX	 <ul style="list-style-type: none"> • Długa, stożkowa końcówka i duża twardość – doskonała jakość mocowania • Najwytrzymalszy gwóźdź do miękkiego betonu i niektórych rodzajów betonu o dużej wytrzymałości

2 PRZEZNACZENIE

2.1 Warunki mocowania

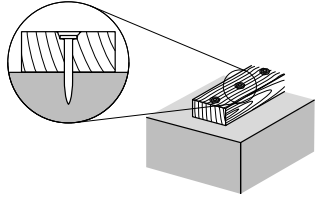
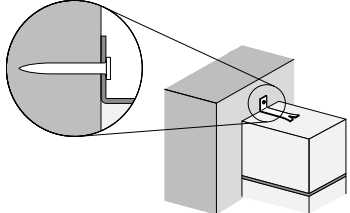
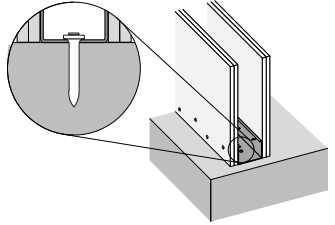
		
Drewno do betonu	Stal do betonu	Stałe mocowanie profilu

2.2 Materiały podłoża

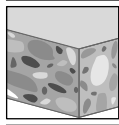
Beton

2.3 Warunki obciążenia

Statyczny/kwazistatyczny

2.4 Warunki środowiskowe

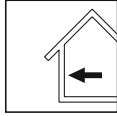

Suche, wewnątrz



- Aby uzyskać więcej informacji, zapoznaj się z informacjami na stronie [Hilti Corrosion Handbook](#).

3 APROBATY I CERTYFIKATY

Instytucja nadzorująca	Aprobata/numer certyfikatu	Data wystawienia
Deutsches Institut für Bautechnik (DIBt)	ETA-20/0886	07.07.2024



- Więcej informacji można znaleźć w zatwierdzeniu/certyfikacie.
- Nie wszystkie informacje przedstawione w niniejszej karcie produktu mogą podlegać zatwierdzeniu/certyfikacji.
- Informacje przedstawione w niniejszej karcie produktu mogą być też oparte na danych technicznych Hilti.
- Zatwierdzenia i certyfikaty ważne przez: X-P 17 B4 MX, X-P 20 B4 MX.

4 DANE PRODUKTU

4.1 Wymiary

Rysunek techniczny	Elementy mocujące	Długość główki L_h [mm]	Długość trzcienia L_s [mm]	Średnica trzcienia d_s [mm]	Średnica główki d_h [mm]
	X-P 17 B4 MX	1,8	17	3	6,8
	X-P 20 B4 MX	1,8	20	3	6,8
	X-P 24 B4 MX	1,8	24	3	6,8

4.2 Właściwości materiału dla części ze stali węglowej

Elementy mocujące	Część składowa	Materiał	Powłoka	Grubość powłoki t_c [μm]	Twardość [HRC]	Kategoria korozyjności
X-P B4 MX	Gwóźdź	Stal węglowa	Ocynkowane	≥5	57,5	C1



- Kategoria korozyjności w atmosferze, zgodnie z normą EN ISO 9223.

4.3 Właściwości materiału dla elementów z tworzyw sztucznych

Elementy mocujące	Część składowa	Materiał	Kolor
X-P B4 MX	Magazynek taśmowy	Polietylen o dużej gęstości (HDPE)	Szary

5 ZALECENIE SYSTEMU

5.1 Narzędzie polecane

Warunek mocowania	Elementy mocujące	Rodzaj urządzenia
Drewno do betonu, Stal do betonu, Stałe mocowanie profilu	X-P B4 MX	BX 4-22 (01)

- Szczegółowe informacje zamieszczono w rozdziale Akcesoria i zgodność materiałów eksploatacyjnych w Podręcznik techniki kotwienia (DFTM)

6 WYMAGANIA DOTYCZĄCE ZAMIERZONYCH ZASTOSOWAŃ

6.1 Właściwości zamocowanego materiału

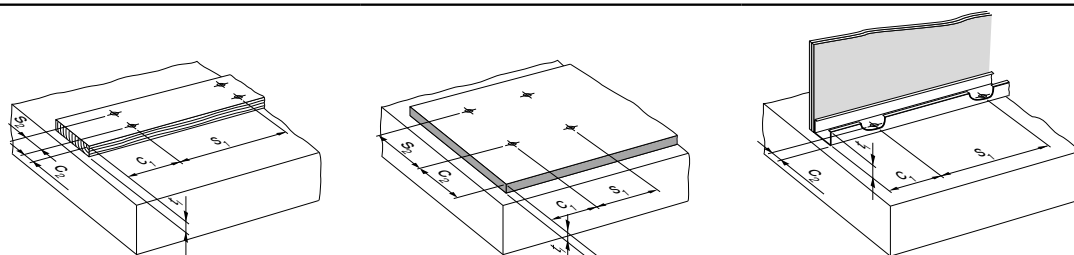

Drewno do betonu

Stal do betonu

Stałe mocowanie profilu

Warunek mocowania	Elementy mocujące	Zamocowany materiał	Grubość mocowanego materiału	Odległość od krawędzi	Odległość od krawędzi	Odległość między elementami mocującymi	Odległość między elementami mocującymi
			t ₁ [mm]	c ₁ [mm]	c ₂ [mm]	s ₁ [mm]	s ₂ [mm]
Drewno do betonu	X-P B4 MX	Drewno	≤ 25	≥ 100	≥ 22	180 – 800	≥ 80
Stal do betonu	X-P B4 MX	Stal	≤ 2	≥ 40		≥ 600	≥ 80
Stałe mocowanie profilu	X-P B4 MX	Tor stalowy	≤ 1	≥ 40		≤ 600	≥ 80

- Odstępny dla ścian działowych z klasyfikacją ogniową: 300 mm.

6.2 Właściwości materiału podłoża

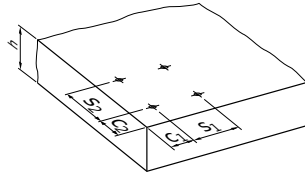

Mocowanie do betonu

Materiał podłoża	Grubość materiału podłoża	Odległość od krawędzi	Odległość od krawędzi	Odległość między elementami mocującymi	Odległość między elementami mocującymi
	h [mm]	c ₁ [mm]	c ₂ [mm]	s ₁ [mm]	s ₂ [mm]
Beton	≥ 60	≥ 70	≥ 70	≥ 100	≥ 80

6.3 Zalecana długość gwoździ

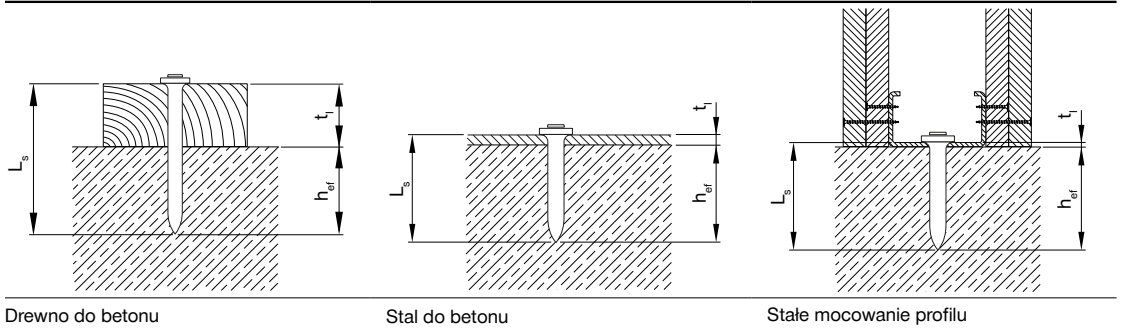

Warunek mocowania	Właściwości mocowania	Długość trzpienia	Głębokość osadzenia	Grubość mocowanego materiału
		L _s [mm]	h _{ef} [mm]	t _i [mm]
Drewno do betonu	Mocowanie standardowe	$L_s \geq h_{ef} + t_i$	≥ 14	≤ 25
	Mocowanie równo z powierzchnią	$L_s \geq h_{ef} + t_i - 3$	≥ 14	≤ 25
Stal do betonu	Mocowanie standardowe	$L_s \geq h_{ef} + t_i$	≥ 11	≤ 2
Stałe mocowanie profilu	Mocowanie standardowe	$L_s \geq h_{ef} + t_i$	≥ 11	≤ 1

7 DANE WŁAŚCIWOŚCI

7.1 Zalecane obciążenia przy obciążeniu kwazistatycznym

Warunek mocowania	Elementy mocujące	Rodzaj materiału podłoża	Głębokość osadzenia	Obciążenie rozciągające	Obciążenie ścinające
			h_{ef} [mm]	N_{rec} [kN]	V_{rec} [kN]
Drewno do betonu	X-P B4 MX	Beton o wyższym stosunku w/c, Beton średni, Twardy beton	14 – < 18	0,1	0,1
		Beton o wyższym stosunku w/c, Beton średni	≥ 18	0,2	0,2
Beton o wyższym stosunku w/c, Beton średni, Twardy beton		11 – < 14	0,1	0,38	
Beton o wyższym stosunku w/c, Beton średni, Twardy beton		14 – < 18	0,1	0,38	
Beton o wyższym stosunku w/c, Beton średni		≥ 18	0,2	0,38	
Stale mocowanie profilu, Stal do betonu					



- Wymagana jest redundancja punktów mocowania.
- Minimalna ilość punktów mocowania dla zamocowań istotnych dla bezpieczeństwa: ≥ 5.

7.2 Ocena współczynnika mocowania

Rysunek techniczny	Warunek mocowania	Rodzaj materiału podłoża	Ocena współczynnika mocowania [%]
	Stale mocowanie profilu, Stal do betonu, Drewno do betonu	Beton o wyższym stosunku w/c	85 – 98
		Beton średni	85 – 98
		Twardy beton	70 – 85



- Szybkość przyklejania może różnić się od powyższych wartości w zależności od warunków w miejscu pracy.
- Współczynnik mocowania oznacza procent gwoździ, które zostały prawidłowo wbite, aby przenosić obciążenie.

8 ZAPEWNIANIE JAKOŚCI

8.1 Inspekcja mocowania

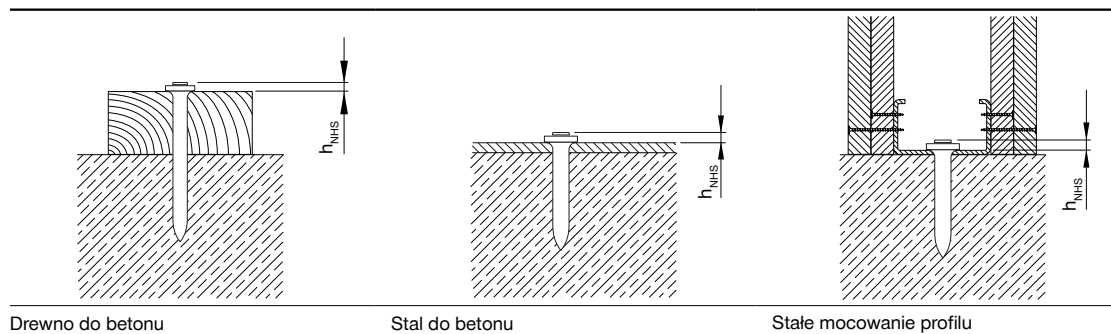

Warunek mocowania	Elementy mocujące	Wystawienie łącznika h_{NHS} [mm]
Drewno do betonu	X-P B4 MX	≤ 3
Stal do betonu, Stałe mocowanie profilu	X-P B4 MX	2 – 5



- Widoczne wadliwe zamocowania trzeba zastąpić nowymi elementami mocującymi, nie w tym samym otworze.
- Niniejszy dokument to wersja skrócona instrukcji, mogących różnić się w zależności od zastosowania.
- Należy zawsze przestrzegać instrukcji dołączonych do danego produktu.

9 INFORMACJE DOTYCZĄCE ZAMAWIANIA

9.1 Nr artykułu i opis

Oznaczenie	Nr artykułu	Opis
X-P 17 B4 MX	2361537, 2361651, 2361655, 2412761, 2412762, 2412763	Gwoździe X-P B4 MX do betonu (magazynkowe)
X-P 20 B4 MX	2361538, 2361652, 2361656, 2412764, 2412765, 2412766	
X-P 24 B4 MX	2361539, 2361653, 2361657, 2412767, 2412768, 2412769	



Hilti Aktiengesellschaft
9494 Schaan, Liechtenstein
P +423-234 2965

www.facebook.com/hiltigroup
www.hilti.group